

European Technical Assessment

ETA-21/0350
 of 10/01/2022

General Part

Technical Assessment Body Issuing the European Technical Assessment:	Element Materials Technology Rotterdam B.V.
Trade Name of the Construction Product:	Hemsec Structural Insulated Panels
Product Family to Which the Construction Product Belongs:	EC PAC 14
Manufacturer:	Hemsec Manufacturing Ltd Stoney Lane Rainhill Prescot Merseyside L35 9LL UK
Manufacturing Plant(s):	Hemsec Manufacturing Ltd Stoney Lane Rainhill Prescot Merseyside L35 9LL UK
This European Technical Assessment Contains:	58 Pages including 2 Annexes which forms an integral part of this assessment.
This European Technical Assessment is Issued in Accordance with Regulation (EU) No 305/2011, On the Basis Of:	EAD 140022-00-0304 – “Pre-fabricated Wood - Based Loadbearing Stressed Skin Panels”
This Version Replaces:	ETA 17/0517, Issued on 30/10/2019

Translations of this European Technical Assessment in other languages shall fully correspond to the original issued document and should be identified as such.

Communication of the European Technical Assessment, including transmission by electronic means, shall be in full (except for any confidential Annexes referred to above). However a partial reproduction may be made with the written consent of the issuing Technical Assessment Body. Any partial reproduction has to be identified as such.

1 Technical Description of the Product

The product “Hemsec SIP” is a double skin sandwich panel with a rigid closed-cell foam core, generally referred to as a Structural Insulated Panel (SIP). The skins are continuous panels of oriented strand board, Class 3 (OSB/3), 15 mm thick.

The core is injected polyurethane (PUR) supplied by BASF Polyurethanes Europe that foams and adheres to the interior faces of the skins. The foam is formed by the reaction of two components with trade names Elastopor H 1236/3 and IsoPMDI 92140. The foam has zero Ozone Depletion Potential and is CFC and HCFC free.

Table 1: Standard Hemsec SIP Panel Layups and Weights

Panel thickness (mm)	100	125	150	175	200	225
Internal OSB/3 thickness (mm)	15	15	15	15	15	15
Foam core thickness (mm)	70	95	120	145	170	195
External OSB/3 thickness (mm)	15	15	15	15	15	15
Weight (kg/m ²)	22.1	23.1	24.2	25.5	26.5	27.6

The product is manufactured by a discontinuous process as a panel 1.2 metres wide and up to 6 metres long.

The geometry of the panel is controlled at the time of manufacture.

Table 2: Hemsec SIP Panel Geometrical Tolerances

Panel Dimension	Target	Tolerance
Length	As specified	+0 / -1 mm
Thickness	As specified	+2 / -3 mm
PUR core width	1198 mm	+3 / -3 mm
OSB/3 face width	1198 mm	+3 / -3 mm
Surface flatness, along length	As specified	± 2%
Surface flatness, across width	As specified	± 2%
Edge alignment between OSB/3 faces	-	≤ 2 mm

The dimensional stability of the Hemsec SIP is taken as the shrinkage and swelling of the OSB/3 in service conditions as declared by the OSB/3 manufacturer. It is expressed as the percentage change in dimension per percentage change in moisture content.

- Length: 0.02 %/%
- Width: 0.03 %/%
- Thickness: 0.5 %/%

Shrinkage and swelling of the polyurethane core is deemed to be negligible

The product may be manufactured so that the OSB/3 faces extend beyond the core creating a groove that is as wide as the core on one or more edges. This groove facilitates the joining of

panels with an insert which may be an OSB/PUR spline or may be a piece of solid strength graded timber.

The basic build-up of the product is shown in Drawings HS-27 and HS-25 in Annex 2.

2 Specification of the Intended Use(s) in Accordance with the Applicable European Assessment Document (hereinafter EAD)

The Hemsec SIP is intended for use as the principal structural component of load bearing walls (including external walls, internal walls and separating or party walls) and pitched roofs. The product has not been assessed for use as floors.

When used in external walls the product should be protected by a weather resistant outer cladding leaf with a ventilated cavity and a breather membrane.

When used as a pitched roofing panel, the product shall be protected by a waterproof and weather resistant outer layer (such as tiling) with a ventilated gap and a breather membrane.

The product is suitable for single and multiple occupancy dwellings as well as commercial, retail and public buildings up to four storeys high, subject to satisfactory engineering calculations.

The product has an estimated expected service life of at least 60 years, provided the product is installed and maintained in accordance with the manufacturer's instructions.

3 Performance of the Product and References to the Methods used for its Assessment

BWR	Characteristic	Assessment of Characteristic
1	Mechanical Resistance and Stability	See ETA Section 3.1.1
2	Safety in Case of Fire	
	Reaction to Fire	See ETA Section 3.1.2.1
	Fire Resistance	See ETA Section 3.1.2.2
3	Hygiene, Health & the Environment	
	Content and Release of Dangerous Substances	See ETA Section 3.1.3.1
	Water Vapour Permeability and Moisture Resistance	See ETA Section 3.1.3.2
4	Safety and Accessibility in Use	
	Impact/shock Resistance	See ETA Section 3.1.4.1
5	Protection against Noise	
	Airborne Sound Insulation	See ETA Section 3.1.5.1
	Sound Absorption	See ETA Section 3.1.5.2
6	Energy Economy & Heat Retention	
	Thermal Conductivity	See ETA Section 3.1.6.1
	Air Permeability	See ETA Section 3.1.6.2
	Thermal Inertia	See ETA Section 3.1.6.3
	Additional Assessment	
	Durability	See ETA Section 3.1.6.2

3.1 Methods of Verification

3.1.1 Mechanical Resistance and Stability

Design values are given in Annex A for the following properties

- Horizontal load capacity for walls.
- Vertical load capacity for walls (with and without eccentricity).
- Combined vertical/horizontal load capacity.
- Racking load capacity for 150 mm thick walls.
- Fixing capacity.
- Roofs.

Values have been determined by calculation models assisted by initial type testing. Testing was conducted with the assumption of axial design loads of up to 80kN/m.

Sampling of test material was supervised by Element Materials Technology Rotterdam B.V. The detailed models and analysis of test data have been evaluated and are kept on file by BMT.

Characteristic 5th percentile, mean and design values have been determined in accordance with the principles of Eurocode 5. The partial material factor γ_M is taken as 1.2 for OSB/3 and 1.3 for solid timber.

For racking resistance, values have been determined by calculation, whereby the table assumes that the OSB/3 edges are supported by contact with a solid substrate. The values are conservative in comparison with test results. Vertically loaded panels will have an enhanced racking resistance. However, if the axial loads at the edges are transferred through the mechanical fasteners only, as is the case where the OSB/3 edges are not in contact with a solid substrate, the racking resistance will be reduced.

For roofs, two sets of tables are provided.

- The first set (Table 15 to Table 17) is for roof capacities for spans up to 3 m measured on the slope. It is based on the performance of the panel without taking any contribution from the joint between panels. The tables are therefore valid for roofs with splines either of OSB/PUR or strength graded timber.
- The second set of tables (Table 18 to Table 20) is for roof capacities for spans from 3 m up to 6 m measured on the slope. The performance is limited by the shear capacity of the mechanical fasteners in the joint between the OSB/3 and a spline of strength graded C16 timber. The mechanical fasteners are 4.9 mm diameter by 45 mm long screws with a spacing of 50 mm for the outer quarters of the span and 100 mm for the inner quarters of the span.

Nails in the joints are 2.8 mm by minimum 50 mm length galvanized ring shank nails with a minimum tensile strength of 600 N/mm² at 50 mm centres.

The design value for the axial withdrawal resistance of a screw perpendicular to the plane of the panel used to anchor a wall tie was determined by test for an instantaneous load duration as 522 N. This value is suitable for use in the calculation of wind resistance where screws equivalent to those tested are used to anchor wall ties.

The tested screw had a diameter of 4 mm and a declared characteristic axial withdrawal resistance of 56 N per mm penetration depth in C24 timber. However, calculations to EN 1995-1-1 were found to be non-conservative in comparison with test results.

3.1.2 Safety in case of Fire

3.1.2.1 Reaction to Fire

Following Commission decision 2003/43/EC the classes that apply to the OSB/3 skins of the Hemsec SIP are:

- D-s2, d0 (excluding floorings), D_{fi}-s1 (floorings)

3.1.2.2 Fire Resistance

The fire resistance of the Hemsec SIP is not determined separately from the performance of the completed structure, in particular the room linings and finishes. Therefore, there is no performance determined for the product. However, fire resistance tests on loaded and unloaded walls with Hemsec SIPs as the principal structural element have achieved FR 60 and FR 90 ratings respectively, depending on the exact test configuration. Refer to Hemsec Manufacturing for details of the tested walls.

3.1.3 Hygiene, Health and the Environment

3.1.3.1 Content and Release of Dangerous Substances

The products Elastopor H 1236/3 and IsoPMDI 92140 supplied by BASF Polyurethanes GmbH are compliant with EC Regulation 1907/2006 (REACH).

The Smartply OSB products supplied by Coillte Group are compliant with EC Regulation 1907/2006 (REACH).

The Hemsec SIP products and their packaging do not contain any products of very high concern as defined by REACH.

The OSB/3 skins fall within the E1 emission class for release of formaldehyde to EN 717-1.

3.1.3.2 Water Vapour Permeability and Moisture Resistance

The water vapour resistance factor μ of the Hemsec SIP is taken as the values for the individual components.

- OSB/3, from manufacturer's declaration: dry cup = 240, wet cup = 150
- Polyurethane foam, from EN ISO 10456: dry cup = 60, wet cup = 60

3.1.4 Safety and Accessibility in Use

3.1.4.1 Impact/shock Resistance

The Hemsec SIP are assessed as having satisfactory impact/shock resistance for normal use in residential housing or office buildings without further testing.

3.1.5 Protection against Noise

3.1.5.1 Airborne Sound Insulation

The airborne sound insulation R_w determined by laboratory tests is:

- Partition composed of 150 mm thick panels only: $R_w = 28$ dB
- Partition as above with 12.5 mm thick "Fireline" plasterboards on both faces supported on 25 × 50 mm softwood battens, creating 25mm unfilled cavities: $R_w = 37$ dB
- Partition as above with additional 12.5 mm thick "Wallboard" plasterboard on both faces: $R_w = 44$ dB

Sound insulation is a property of all the components and workmanship of the partition as installed, not just the SIPS product. The airborne sound insulation of walls and floors between dwellings is often determined by in-situ testing. The requirements for acoustic performance may vary by Member State.

3.1.5.2 Sound Absorption

The sound absorption coefficient α of the Hemsec SIP is taken as the value of the OSB/3 skin as declared by the OSB manufacturer in accordance with EN 13986.

- Sound absorption α (200 – 500 Hz) = 0.10
- Sound absorption α (1000 – 2000 Hz) = 0.25

3.1.6 Energy Economy and Heat Retention

3.1.6.1 Thermal Conductivity

The declared value for aged thermal conductivity of the core material λ_D is determined from tests in accordance with EN13165. Thermal resistance values are given below for the standard core thicknesses.

Table 3: Thermal conductivity λ_D and resistance R_D values for the PUR Core of Standard Hemsec SIP panel layups

Panel thickness (mm)	100	125	150	175	200	225
PUR Core thickness (mm)	70	95	120	145	170	195
Design thermal conductivity λ_D (W/mK)	0.030	0.029	0.028	0.028	0.028	0.028
Design thermal resistance R_D (m ² K/W)	2.30	3.25	4.25	5.15	6.05	7.35

The thermal conductivity λ of the OSB/3 skins is given as 0.11 W/mK. The thermal resistance R is 0.14 m²K/W per 15 mm face.

Thermal properties for the standard panel layups are given below. The values are determined by calculation and include values for internal resistance R_{si} and external resistance R_{se} of 0.13 and 0.04 m²K/W respectively.

Table 4: Calculated Thermal Properties for Standard Hemsec SIP Panel Layups

Panel thickness (mm)	100	125	150	175	200	225
Thermal transmittance of the panel U (W/m ² K)	0.36	0.27	0.21	0.18	0.15	0.14
Thermal resistance of the panel R (m ² K/W)	2.75	3.70	4.70	5.60	6.50	7.35

3.1.6.2 Air Permeability

Air permeability is determined by air leakage testing of the whole structure. It is not determined separately for the Hemsec SIP product. The indicative construction details in Annex 2 have been assessed for air permeability.

3.1.6.3 Thermal Inertia

The specific heat capacity (thermal inertia) c_p for the Hemsec SIP is taken as the values for the individual components from EN ISO 10456.

- OSB: $c_p = 1700$ J/(kg K)
- Polyurethane foam (density 30 – 50 kg/m³): $c_p = 1400$ J/(kg K)

3.1.7 Durability

The Hemsec SIP can be used in Service Classes SC1 and SC2 as specified in EN 1995-1-1, which corresponds principally to Use Class UC1 as defined in EN 335. The OSB/3 skins are suitable for UC1 and UC2 conditions.

3.2 General Aspects Related to the Performance of the Product

3.2.1 Manufacturing

The Hemsec SIPs are manufactured in accordance with the provisions of this European Technical Assessment using the manufacturing process assessed and detailed in the technical documentation.

The European Technical Assessment is issued for the products covered on the basis of agreed data/information that has been deposited with Element Materials Technology Rotterdam B.V. and which identifies the products that have been assessed and judged.

Changes to the products or the manufacturing process, that may result in the information submitted and held on file being incorrect, should be confirmed with Element Materials Technology Rotterdam B.V. before any modifications are implemented.

Element Materials Technology Rotterdam B.V. will decide on that basis whether or not such changes may affect the performance characteristics detailed in the ETAs and consequently the validity of the CE-marking. In that case additional assessment or modifications to the ETA and the corresponding evaluation report may be necessary.

3.2.2 Design of the Product

The extent of the responsibility that Hemsec Manufacturing Ltd takes for design, in accordance with Guidance Paper L is:

- Method 2:
Declares properties of the product as a composite whole as characteristic or design values in accordance with a format that allows the engineer to incorporate the product in a Eurocode design).

Hemsec provides a set of indicative construction details to support structural engineers and designers – see Annex B.

3.2.3 Installation of the Product

3.2.3.1 Installation Instructions

It is the manufacturer's responsibility to ensure that the specific instructions for installation are made available to the purchaser. This information may be made by reproduction of the respective parts of the European Technical Assessment.

In addition all data for installation and intended use shall be shown clearly on the package and/or on an enclosed instruction sheet.

Hemsec provides a comprehensive installation manual and building site guidelines.

The following details must be within the tolerance of ± 5 mm

- The level of the foundation or other bearing support.
- The overall width and length of the building footprint.

To ensure the long-term performance of the product, it is important the product is protected from wetting on site and is installed in a dry condition. In particular, the product should not be enclosed by fixing plasterboard and membranes in place if it is wet.

The product should be installed so that the edges of the OSB/3 faces are directly supported by the bearing surface below, unless the designer has made allowance for all the vertical and racking forces to be transferred through the mechanical fasteners.

The product should not be modified on site by machining grooves or holes in the OSB/3 faces (e.g. for service penetrations) unless these have been allowed for in the structural calculations and the design for fire resistance.

For more general guidance, Hemsec also refer to the STA publication "SIP construction – A useful pocket site guide".

3.2.4 Packaging, Transport and Storage

Packs of panels are no more than 1.2 metre high (e.g., 12 panels, 100 mm thick). They are tightly strapped, with protectors under the straps and at corners. Packs are protected by weatherproof shrink-wrap and may be stored in the open for a few weeks, provided the shrink wrap is not damaged.

Packs shall be supported on bearers at a maximum of 1600 mm either side of the centre line of the panel. The number of bearers varies with panel length. Packs may be stacked separated by vertically aligned bearers. Panels shall be stored horizontally until installation.

Panel should not be lifted solely by their faces.

3.2.5 Use, Maintenance and Repair

The assessment of the fitness for use is based on the assumption that maintenance is not required during the assumed intended working life.

Damaged panels shall not be installed.

Should repair of the installation become necessary, the complete panel shall be replaced.

4 Assessment and Verification of Constancy of Performance (hereinafter AVCP) System Applied, with reference to its Legal Base

4.1 System of Assessment and Verification of Constancy of Performance

According to the Decision 97/176/EC of the European Commission the System of Assessment and Verification of Constancy of Performance (see Annex V to Regulation (EU) No 305/2011) is 1.

5 Technical Details necessary for the Implementation of the AVCP System, as foreseen in the applicable EAD

5.1 Tasks for the Manufacturer

5.1.1 Factory Production Control (FPC)

The Manufacturer has a Factory Production Control (FPC) system and exercises permanent internal control of production. All the elements, requirements and provisions adopted by the manufacturer are documented in a systematic manner in the form of policies, procedures and work instructions. This FPC system ensures that the product is in conformity with this European Technical Assessment.

The Manufacturer shall only use raw materials or components that are supplied with the relevant inspection documents or conformity declarations. All incoming raw materials shall be subject to inspection, verification, controls and tests (as applicable) by the manufacturer.

The results of FPC are recorded and evaluated. These records include but are not limited to:

- Product specification and designation, basic materials and components

- Type(s) of Control testing
- Date of manufacture of the product and date of testing of the product or basic material and components;
- Result of control and testing and, if appropriate, comparison with requirements;
- Signature of the person responsible for FPC

These records shall be presented to Element Materials Technology Rotterdam B.V. upon request.

Complete panels are checked for:

- Dimensional and geometrical accuracy
- Visible defects and finish quality

Specimens of the whole panel thickness are checked for

- Tensile strength in the plane of the board
- Overall density

Specimens of the closed cell foam core are checked for:

- Core density
- Thermal conductivity

5.2 Tasks for the Notified Body

5.2.1 Initial Type Testing

Initial Type Testing (ITT) has been undertaken under the responsibility of Element Materials Technology Rotterdam B.V. to verify that the production line/s in question is able to manufacture products in conformity with this ETA.

Whenever a change occurs in materials or production process which would significantly change the characteristics of the product as described in this ETA, the tests or assessments shall be repeated for the appropriate characteristics.

5.2.2 Initial Inspection of Factory and of Factory Production Control

The Notified Body shall ascertain that the factory and the factory production control are suitable to ensure continuous and orderly manufacturing of the product according to the specifications mentioned in Section 2, as well as to the Annexes to this European Technical Assessment.

5.2.3 Continuing Surveillance

The Notified Body shall visit each Production Unit / Factory twice a year for regular inspection. It shall be verified that the system of factory production control and the specified manufacturing process is maintained in accordance with this European Technical Assessment.

The results of product certification and continuing surveillance shall be made available on demand by the certification body or inspection body. In cases where the provisions of this European Technical Assessment and the prescribed test plan are no longer fulfilled, the conformity certificate shall be withdrawn.

Issued in Amsterdam, Netherlands on dd/mm/2021

By

A handwritten signature in black ink, appearing to read 'Niresh D Somlie', with a long horizontal flourish underneath.

Niresh D Somlie

Technical Assessment Body Manager

Annex 1: Mechanical Resistance – Characteristic Values

Notes to the all the Mechanical Resistance tables:

- Fasteners are 2.8 mm diameter by minimum 50 mm length galvanized ring shank nails with a minimum tensile strength of 600 N/mm², unless otherwise stated
- The self-weight of the panel(s) should be included in the design loading unless otherwise stated
- The tables assume Service Class 2 values for k_{mod} from Table 3.1 of EN1995-1-1 for OSB/3 or strength graded solid timber, as appropriate.
- The tables assume a partial factor for material properties γ_M from Table 2.3 of EN1995-1-1 of 1.2 for OSB/3 and 1.3 for strength graded solid timber and connections.
- The tables do not take account of the effects of holes or openings through the panels e.g., for windows
- The tables assume that there are no holes or grooves in either face of the panel, e.g., for installing services.
- SIPs are to be installed in accordance with Hemsec's installation instructions

Additional notes for long term and permanent loading tables (Table 21 and Table 22 respectively).

- The values for long term loading and permanent loading do not take account of the effects of deflections due to creep. Such calculations are dependent upon the design life chosen and should be calculated separately.
- The roof panel loading tables are calculated on the limiting shear capacity of the panel or of 75 mm wide timber inserts (whichever is lower). Additional load capacity may be possible by using wider timber inserts.
- An upper bound load limit of 5 kN/m² and a lower bound load limit of 0.2 kN/m² has been applied to these load tables. Consult the manufacturer for loading conditions which fall outside these limits.
- Consult the manufacturer for allowable loading on panels which extend over multiple spans.
- Consult the manufacturer where there is any doubt as to the limitations of allowable loading on the panels.

Table 5: Moment Capacity for Hemsec SIPs

Panel Thickness (mm)	Characteristic Moment (kNm)	Moment Capacities (kN/m)			
		Permanent	Long Term	Medium Term	Short Term
100	6.74	1.69	2.25	3.09	3.93
125	9.15	2.29	3.05	4.19	5.34
150	11.56	2.89	3.85	5.30	6.74
175	10.63	2.66	3.54	4.87	6.20
200 / 225	15.45	3.86	5.15	7.08	9.01

Notes:

- Values are for a 1.2 m wide panel.
- Nail spacing is 75 mm centres.

Table 6: Horizontal Load Capacity for Hemsec SIPs used as Wall Panels

Panel Thickness (mm)	Panel Height (m)	Horizontal Load Capacity (kN/m ²)	
		Short Term	Instantaneous
100	2.4	3.03	3.87
	2.7	2.70	3.02
	3.0	2.39	2.39
125	2.4	4.12	5.26
	2.7	3.66	4.20
	3.0	3.29	3.39
150	2.4	5.20	6.69
	2.7	4.62	5.79
	3.0	4.16	4.72
175	2.4	6.29	8.00
	2.7	5.59	6.67
	3.0	4.59	5.53
200 / 225	2.4	7.37	8.00
	2.7	6.55	8.00
	3.0	5.89	6.78

Notes:

- Vertical loads are applied concentrically to the panel
- Loads are applied to the face of the panel
- Self-weight is excluded as it does not cause bending to a wall panel

Table 7: Vertical Load Capacity for Hemsec SIPs – No Eccentricity

Panel Thickness (mm)	Panel Height (m)	Vertical Load Capacity (kN/m)			
		Long Term	Medium Term	Short Term	Instantaneous
100	2.4	57	78	80	80
	2.7	50	69	80	80
	3.0	44	61	78	80
125	2.4	76	80	80	80
	2.7	68	80	80	80
	3.0	62	80	80	80
150	2.4	80	80	80	80
	2.7	80	80	80	80
	3.0	80	80	80	80
175	2.4	80	80	80	80
	2.7	80	80	80	80
	3.0	80	80	80	80
200 / 225	2.4	80	80	80	80
	2.7	80	80	80	80
	3.0	80	80	80	80

Notes:

- Vertical loads are applied concentrically to the panel
- Horizontal load has not been applied

Table 8: Vertical Load Capacity for Hemsec SIPs – Eccentricity = 21 mm from Face

Panel Thickness (mm)	Panel Height (m)	Vertical Load Capacity (kN/m)			
		Long Term	Medium Term	Short Term	Instantaneous
100	2.4	46	63	80	80
	2.7	41	57	72	80
	3.0	37	51	65	80
125	2.4	48	66	80	80
	2.7	48	66	80	80
	3.0	48	66	80	80
150	2.4	56	77	80	80
	2.7	56	77	80	80
	3.0	56	77	80	80
175	2.4	56	77	80	80
	2.7	56	77	80	80
	3.0	56	77	80	80
200 / 225	2.4	56	77	80	80
	2.7	56	77	80	80
	3.0	56	77	80	80

Notes:

- Vertical loads are applied eccentrically to the panel with the line of action of the load set 21 mm inboard from the face of the sheathing. Consult Hemsec for other eccentricities
- Horizontal load has not been applied

Table 9: Combined Vertical/Horizontal Load Capacity for 100 mm thick Hemsec SIPs

Panel Height (m)	Vertical Load		Horizontal Load Capacity (kN/m ²)	
	Short Term (kN/m)	Eccentricity (mm)	Short Term	Instantaneous
2.4	0	0	3.03	3.87
2.4	50	0	1.66	2.13
2.4	50	29.5	N/A	0.54
2.4	80	0	0.52	0.66
2.4	80	29.5	N/A	N/A
2.7	0	0	2.70	3.02
2.7	50	0	1.07	1.38
2.7	50	29.5	N/A	N/A
2.7	80	0	N/A	0.52
2.7	80	29.5	N/A	N/A
3.0	0	0	2.39	2.39
3.0	50	0	0.68	0.87
3.0	50	29.5	N/A	N/A
3.0	80	0	N/A	N/A
3.0	80	29.5	N/A	N/A

Notes:

- Vertical loads are applied concentrically to the panel
- Loads are applied to the face of the panel
- Self-weight is excluded as it does not cause bending to a wall panel

Table 10: Combined Vertical/Horizontal Load Capacity for 125 mm thick Hemsec SIPs

Panel Height (m)	Vertical Load		Horizontal Load Capacity (kN/m ²)	
	Short Term (kN/m)	Eccentricity (mm)	Short Term	Instantaneous
2.4	0	0	4.12	5.26
2.4	50	0	3.09	3.31
2.4	50	42	1.10	1.41
2.4	80	0	1.67	2.15
2.4	80	42	N/A	N/A
2.7	0	0	3.66	4.20
2.7	50	0	2.21	2.57
2.7	50	42	0.81	1.04
2.7	80	0	1.05	1.35
2.7	80	42	N/A	N/A
3.0	0	0	3.29	3.39
3.0	50	0	1.61	2.02
3.0	50	42	0.73	0.93
3.0	80	0	0.64	0.82
3.0	80	42	N/A	N/A

Notes:

- Vertical loads are applied concentrically to the panel
- Loads are applied to the face of the panel
- Self-weight is excluded as it does not cause bending to a wall panel

Table 11: Combined Vertical/Horizontal Load Capacity for 150 mm thick Hemsec SIPs

Panel Height (m)	Vertical Load		Horizontal Load Capacity (kN/m ²)	
	Short Term (kN/m)	Eccentricity (mm)	Short Term	Instantaneous
2.4	0	0	5.20	6.69
2.4	50	0	4.42	4.82
2.4	50	54.5	2.21	2.85
2.4	80	0	2.77	3.56
2.4	80	54.5	0.57	0.73
2.7	0	0	4.62	5.79
2.7	50	0	3.43	3.82
2.7	50	54.5	1.70	2.18
2.7	80	0	2.12	2.72
2.7	80	54.5	N/A	0.53
3.0	0	0	4.16	4.72
3.0	50	0	2.69	3.05
3.0	50	54.5	1.32	1.70
3.0	80	0	1.60	2.06
3.0	80	54.5	N/A	N/A

Notes:

- Vertical loads are applied concentrically to the panel
- Loads are applied to the face of the panel
- Self-weight is excluded as it does not cause bending to a wall panel

Table 12: Combined Vertical/Horizontal Load Capacity for 175 mm thick Hemsec SIPs

Panel Height (m)	Vertical Load		Horizontal Load Capacity (kN/m ²)	
	Short Term (kN/m)	Eccentricity (mm)	Short Term	Instantaneous
2.4	0	0	6.29	8.00
2.4	50	0	4.15	5.33
2.4	50	67	2.22	2.85
2.4	80	0	2.63	3.38
2.4	80	67	0.63	0.80
2.7	0	0	5.59	6.67
2.7	50	0	2.41	3.10
2.7	50	67	1.73	2.23
2.7	80	0	0.84	1.08
2.7	80	67	N/A	0.61
3.0	0	0	4.59	5.53
3.0	50	0	1.93	2.48
3.0	50	67	1.38	1.77
3.0	80	0	0.67	0.86
3.0	80	67	N/A	N/A

Notes:

- Vertical loads are applied concentrically to the panel
- Loads are applied to the face of the panel
- Self-weight is excluded as it does not cause bending to a wall panel

Table 13: Combined Vertical/Horizontal Load Capacity for 200 mm / 225 mm thick Hemsec SIPs

Panel Height (m)	Vertical Load		Horizontal Load Capacity (kN/m ²)	
	Short Term (kN/m)	Eccentricity (mm)	Short Term	Instantaneous
2.4	0	0	7.37	8.00
2.4	50	0	4.61	5.93
2.4	50	79.5	3.52	4.53
2.4	80	0	1.66	2.13
2.4	80	79.5	1.07	1.37
2.7	0	0	6.55	8.00
2.7	50	0	3.61	4.64
2.7	50	79.5	2.77	3.57
2.7	80	0	1.29	1.66
2.7	80	79.5	0.83	1.07
3.0	0	0	5.89	6.78
3.0	50	0	2.89	3.72
3.0	50	79.5	2.22	2.86
3.0	80	0	1.03	1.32
3.0	80	79.5	0.65	0.84

Notes:

- Vertical loads are applied concentrically to the panel
- Loads are applied to the face of the panel
- Self-weight is excluded as it does not cause bending to a wall panel

Table 14: Racking Resistance and Stiffness for Hemsec SIPs – Instantaneous Loading

Panel Height (m)	Racking Resistance (kN)	Racking Stiffness (N/mm)
2.4	17.0	3963
2.7	15.3	3522
3.0	13.9	3170

Notes:

- Values assume an overall wall length of 2.4 m. Values for longer walls may be calculated pro rata
- Values apply to all standard thicknesses described in this ETA with 15 mm OSB/3 faces
- Nail spacing is 50 mm. Values for other nail spacings can be calculated by Hemsec
- The calculation assumes that the edges of the OSB/3 faces are in contact with the sole or base plate. Recommendation is for a solid support. Since OSB/3 has a characteristic edge compression strength of 15.4 N/mm², the use of C16 strength graded timber would reduce the racking resistance and the designer should satisfy themselves as to the suitability
- Where uplift exceeds the vertical load of panel, additional fixings should be provided
- Self-weight is excluded as it does not cause racking to a wall panel

Figure 1: Indicative Elevation Detail for Roofs in Table 15 to Table 17

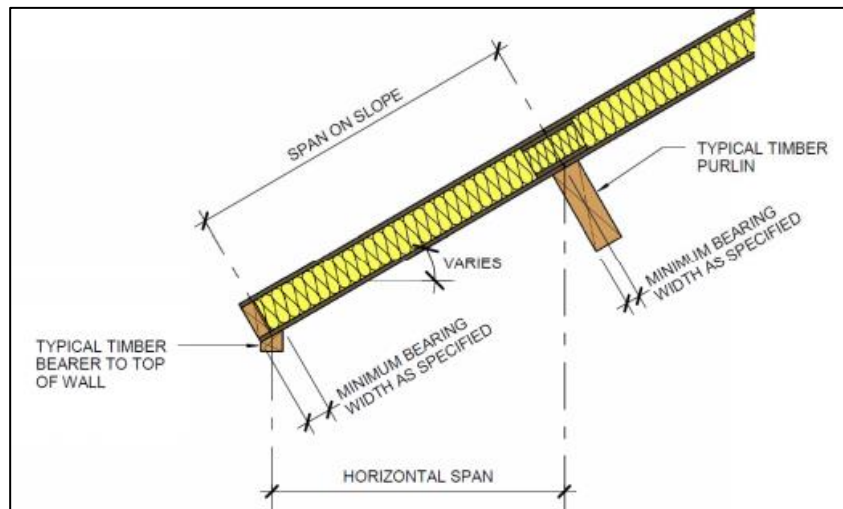

Figure 2: Indicative Section Detail for Roofs in Table 15 to Table 17

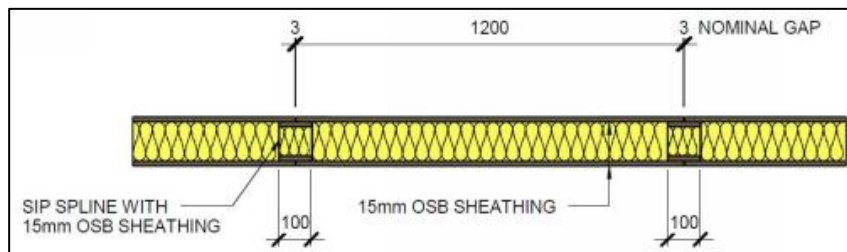

Figure 3: Indicative Construction Detail for Roofs in Table 18 to Table 20

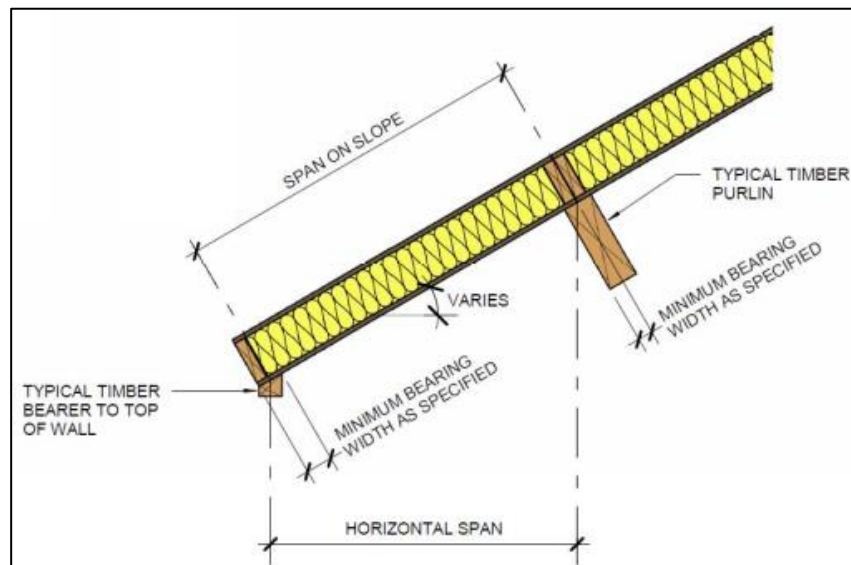

Figure 4: Indicative Section Detail for Roofs in Table 15 to Table 17

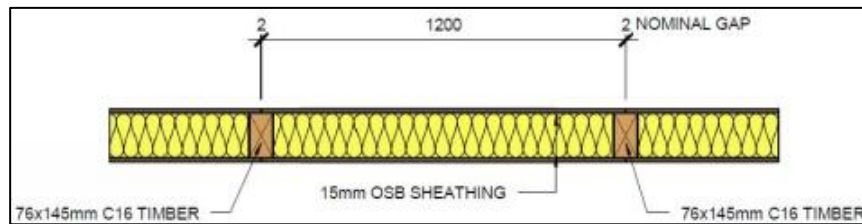

Table 15: Roof Structural Capacities for Hemsec SIPs with OSB/PUR Splines – Medium Term Loading

Panel Thickness (mm)	Panel Span (m)	Panel Design Capacities (kN/m ²)				
		Roof Slope				
		0°	15°	30°	45°	60°
100	1.5	3.54	3.68	4.17	5.20	7.49
	2.0	2.59	2.70	3.07	3.85	5.58
	2.5	2.01	2.10	2.40	3.04	4.44
	3.0	1.63	1.71	1.96	2.50	3.68
125	1.5	4.90	5.09	5.74	7.13	8.00
	2.0	3.61	3.75	4.25	5.30	7.63
	2.5	2.83	2.95	3.35	4.20	6.07
	3.0	2.31	2.41	2.75	3.47	5.04
150	1.5	6.26	6.50	7.31	8.00	8.00
	2.0	4.63	4.81	5.42	6.74	8.00
	2.5	3.65	3.80	4.29	5.35	7.71
	3.0	2.99	3.12	3.54	4.43	6.40
175	1.5	7.63	7.91	8.00	8.00	8.00
	2.0	5.65	5.87	6.60	8.00	8.00
	2.5	4.47	4.64	5.24	6.51	8.00
	3.0	3.33	3.47	3.93	4.91	7.08
200 / 225	1.5	8.00	8.00	8.00	8.00	8.00
	2.0	6.67	6.93	7.78	8.00	8.00
	2.5	5.28	5.49	6.18	7.67	8.00
	3.0	4.36	4.53	5.11	6.36	8.00

Notes:

- Loads are applied to the face of the panel in addition to the self-weight
- The bearing stress at the supports shall be limited to 92 kN/m² bearing

Table 16: Roof Structural Capacities for Hemsec SIPs with OSB/PUR Splines – Short Term Loading

Panel Thickness (mm)	Panel Span (m)	Panel Design Capacities (kN/m ²)				
		Roof Slope				
		0°	15°	30°	45°	60°
100	1.5	4.58	4.76	5.37	6.67	8.00
	2.0	3.37	3.50	3.97	4.95	7.14
	2.5	2.64	2.75	3.13	3.93	5.69
	3.0	1.72	1.80	2.06	2.62	3.84
125	1.5	6.31	6.56	7.37	8.00	8.00
	2.0	4.67	4.85	5.47	6.79	8.00
	2.5	3.68	3.83	4.33	5.40	7.77
	3.0	2.55	2.66	3.03	3.80	5.52
150	1.5	8.00	8.00	8.00	8.00	8.00
	2.0	5.97	6.20	6.97	8.00	8.00
	2.5	4.72	4.90	5.53	6.87	8.00
	3.0	3.66	3.81	4.30	5.37	7.73
175	1.5	8.00	8.00	8.00	8.00	8.00
	2.0	7.27	7.54	8.00	8.00	8.00
	2.5	5.76	5.98	6.73	8.00	8.00
	3.0	4.32	4.49	5.06	6.30	8.00
200 / 225	1.5	8.00	8.00	8.00	8.00	8.00
	2.0	8.00	8.00	8.00	8.00	8.00
	2.5	6.80	7.06	7.93	8.00	8.00
	3.0	5.37	5.58	6.28	7.79	8.00

Notes:

- Loads are applied to the face of the panel in addition to the self-weight
- The bearing stress at the supports shall be limited to 92 kN/m² bearing

Table 17: Roof Structural Capacities for Hemsec SIPs with OSB/PUR Splines – Instantaneous Loading

Panel Thickness (mm)	Panel Span (m)	Panel Design Capacities (kN/m ²)				
		Roof Slope				
		0°	15°	30°	45°	60°
100	1.5	5.97	6.20	6.97	8.00	8.00
	2.0	4.33	4.50	5.08	6.32	8.00
	2.5	2.69	2.80	3.18	3.99	5.79
	3.0	1.72	1.80	2.06	2.62	3.84
125	1.5	8.00	8.00	8.00	8.00	8.00
	2.0	5.78	6.00	6.75	8.00	8.00
	2.5	3.79	3.94	4.45	5.55	7.98
	3.0	2.55	2.66	3.03	3.80	5.52
150	1.5	8.00	8.00	8.00	8.00	8.00
	2.0	7.75	8.00	8.00	8.00	8.00
	2.5	5.29	5.50	6.19	7.68	8.00
	3.0	3.66	3.81	4.30	5.37	7.73
175	1.5	8.00	8.00	8.00	8.00	8.00
	2.0	8.00	8.00	8.00	8.00	8.00
	2.5	6.06	6.30	7.08	8.00	8.00
	3.0	4.34	4.51	5.09	6.32	8.00
200 / 225	1.5	8.00	8.00	8.00	8.00	8.00
	2.0	8.00	8.00	8.00	8.00	8.00
	2.5	7.40	7.68	8.00	8.00	8.00
	3.0	5.37	5.58	6.28	7.79	8.00

Notes:

- Loads are applied to the face of the panel in addition to the self-weight
- The bearing stress at the supports shall be limited to 92 kN/m² bearing

Table 18: Roof Structural Capacities for Hemsec SIPs with C16 Splines – Medium Term Loading

Panel Thickness (mm)	Panel Span (m)	Panel Design Capacities (kN/m ²)				
		Roof slope				
		0°	15°	30°	45°	60°
100	3.0	0.70	0.75	0.90	1.23	1.90
	4.0	0.44	0.48	0.60	0.86	1.39
	5.0	0.28	0.32	0.43	0.64	1.07
	6.0	0.07	0.10	0.18	0.34	0.65
125	3.0	1.04	1.10	1.30	1.71	2.59
	4.0	0.70	0.74	0.90	1.22	1.90
	5.0	0.49	0.53	0.66	0.93	0.04
	6.0	0.35	0.39	0.50	0.74	1.21
150	3.0	1.41	1.48	1.72	2.23	3.32
	4.0	0.97	1.03	1.22	1.61	2.45
	5.0	0.71	0.76	0.92	1.24	1.92
	6.0	0.53	0.58	0.71	0.99	1.57
175	3.0	1.79	1.88	2.17	2.77	4.09
	4.0	1.26	1.33	1.55	2.02	3.02
	5.0	0.94	1.00	1.18	1.57	2.39
	6.0	0.73	0.78	0.94	1.27	1.96
200 / 225	3.0	2.20	2.30	2.64	3.35	4.90
	4.0	1.56	1.64	1.90	2.45	3.63
	5.0	1.18	1.25	1.46	1.91	2.87
	6.0	0.93	0.99	1.17	1.55	2.37

Notes:

- Loads are applied to the face of the panel in addition to the self-weight
- The bearing stress at the supports shall be limited to 92 kN/m² bearing – minimum bearing width is 75 mm

Table 19: Roof Structural Capacities for Hemsec SIPs with C16 Splines – Short Term Loading

Panel Thickness (mm)	Panel Span (m)	Panel Design Capacities (kN/m ²)				
		Roof Slope				
		0°	15°	30°	45°	60°
100	3.0	1.24	1.31	1.53	2.00	3.00
	4.0	0.85	0.90	1.08	1.44	2.21
	5.0	0.50	0.54	0.68	0.95	1.51
	6.0	0.15	0.18	0.27	0.46	0.81
125	3.0	1.77	1.85	2.14	2.74	4.04
	4.0	1.24	1.31	1.53	1.99	2.99
	5.0	0.93	0.98	1.17	1.55	0.08
	6.0	0.50	0.54	0.68	0.95	1.51
150	3.0	2.32	2.43	2.78	3.53	5.00
	4.0	1.66	1.74	2.01	2.58	3.82
	5.0	1.26	1.33	1.55	2.02	3.03
	6.0	0.96	1.01	1.20	1.59	2.42
175	3.0	2.91	3.04	3.46	4.36	5.00
	4.0	2.10	2.20	2.52	3.21	4.71
	5.0	1.61	1.69	1.96	2.52	3.73
	6.0	1.29	1.36	1.58	2.06	3.08
200 / 225	3.0	3.53	3.68	4.18	5.00	5.00
	4.0	2.57	2.68	3.06	3.87	5.00
	5.0	1.99	2.08	2.39	3.05	4.48
	6.0	1.60	1.68	1.94	2.50	3.70

Notes:

- Loads are applied to the face of the panel in addition to the self-weight
- The bearing stress at the supports shall be limited to 92 kN/m² bearing – minimum bearing width is 75 mm

Table 20: Roof Structural Capacities for Hemsec SIPs with C16 Splines – Instantaneous Loading

Panel Thickness (mm)	Panel Span (m)	Panel Design Capacities (kN/m ²)				
		Roof Slope				
		0°	15°	30°	45°	60°
100	3.0	1.70	1.78	2.06	2.64	3.90
	4.0	1.19	1.25	1.47	1.92	2.88
	5.0	0.50	0.54	0.68	0.95	1.51
	6.0	0.15	0.18	0.27	0.46	0.81
125	3.0	2.37	2.48	2.83	3.59	5.00
	4.0	1.69	1.78	2.05	2.63	3.89
	5.0	1.09	1.15	1.36	1.78	0.08
	6.0	0.50	0.54	0.68	0.95	1.51
150	3.0	3.09	3.22	3.66	4.60	5.00
	4.0	2.23	2.33	2.67	3.39	4.97
	5.0	1.72	1.80	2.08	2.67	3.94
	6.0	0.96	1.01	1.20	1.59	2.42
175	3.0	3.84	4.00	4.53	5.00	5.00
	4.0	2.80	2.92	3.33	4.19	5.00
	5.0	2.17	2.27	2.60	3.31	4.85
	6.0	1.52	1.60	1.85	2.39	3.55
200 / 225	3.0	4.64	4.83	5.00	5.00	5.00
	4.0	3.40	3.54	4.02	5.00	5.00
	5.0	2.65	2.77	3.16	3.99	5.00
	6.0	2.15	2.25	2.58	3.28	4.81

Notes:

- Loads are applied to the face of the panel in addition to the self-weight
- The bearing stress at the supports shall be limited to 92 kN/m² bearing – minimum bearing width is 75 mm

Table 21: Roof Structural Capacities for Hemsec SIPs with C16 Splines – Long Term Loading

Panel Thickness (mm)	Panel Span (m)	Panel Design Capacities (kN/m ²)				
		Roof Slope				
		0°	15°	30°	45°	60°
100	3.0	0.42	0.45	0.58	0.83	1.34
	4.0	0.23	0.26	0.36	0.56	0.96
	5.0	N/A	N/A	0.23	0.40	0.74
	6.0	N/A	N/A	N/A	0.29	0.58
125	3.0	0.66	0.71	0.87	1.18	1.84
	4.0	0.41	0.45	0.58	0.82	1.34
	5.0	0.26	0.30	0.40	0.61	1.03
	6.0	N/A	N/A	0.29	0.47	0.83
150	3.0	0.93	0.99	1.17	1.55	2.37
	4.0	0.61	0.66	0.81	1.11	1.73
	5.0	0.42	0.46	0.59	0.84	1.35
	6.0	0.30	0.33	0.44	0.66	1.10
175	3.0	1.21	1.28	1.50	1.95	2.93
	4.0	0.82	0.88	1.05	1.40	2.15
	5.0	0.59	0.64	0.78	1.07	1.69
	6.0	0.44	0.47	0.60	0.86	1.38
200 / 225	3.0	1.51	1.58	1.84	2.37	3.52
	4.0	1.05	1.11	1.30	1.72	2.60
	5.0	0.77	0.82	0.98	1.33	2.04
	6.0	0.58	0.63	0.77	1.06	1.68

Notes:

- Loads are applied to the face of the panel in addition to the self-weight
- The bearing stress at the supports shall be limited to 92 kN/m² bearing – minimum bearing width is 75 mm

Table 22: Roof Structural Capacities for Hemsec SIPs with C16 Splines – Permanent Loading

Panel Thickness (mm)	Panel Span (m)	Panel Design Capacities (kN/m ²)				
		Roof Slope				
		0°	15°	30°	45°	60°
100	3.0	0.23	0.26	0.36	0.56	0.96
	4.0	N/A	N/A	N/A	0.36	0.68
	5.0	N/A	N/A	N/A	0.24	0.51
	6.0	N/A	N/A	N/A	N/A	0.40
125	3.0	0.41	0.45	0.58	0.82	1.34
	4.0	0.23	0.26	0.36	0.56	0.96
	5.0	N/A	N/A	0.23	0.40	0.73
	6.0	N/A	N/A	N/A	0.29	0.58
150	3.0	0.61	0.66	0.81	1.11	1.73
	4.0	0.38	0.41	0.53	0.77	1.26
	5.0	0.23	0.26	0.37	0.57	0.97
	6.0	N/A	N/A	0.26	0.43	0.78
175	3.0	0.82	0.88	1.05	1.40	2.15
	4.0	0.53	0.58	0.71	0.99	1.57
	5.0	0.36	0.39	0.51	0.75	1.22
	6.0	0.24	0.27	0.38	0.58	0.99
200 / 225	3.0	1.05	1.11	1.30	1.72	2.60
	4.0	0.70	0.75	0.91	1.23	1.91
	5.0	0.49	0.53	0.67	0.93	1.49
	6.0	0.35	0.39	0.51	0.74	1.21

Notes:

- Loads are applied to the face of the panel in addition to the self-weight
- The bearing stress at the supports shall be limited to 92 kN/m² bearing – minimum bearing width is 75 mm

Table 23: Panel Deflection Criteria for Hemsec SIPs for Flexural and Shear Stiffness

Panel Thickness (mm)	EI (kN m²)	k_{def}	GA (kN m²)	k_{def}
100	249.9	2.25	459.0	5.56
125	416.9	2.25	518.9	5.56
150	627.0	2.25	663.4	5.56
175	880.0	2.25	668.6	5.56
200 / 225	1176.2	2.25	773.4	5.56

Notes:

- Values are for a 1.2 m wide panel
- Values of k_{def} are for Service Class 2
- For serviceability calculations, deflection due to both shear and bending should be considered.
- Appropriate deflection limits should be determined to suit the project design life and loading conditions.

Annex 2: Indicative Construction Details

Note that the attached construction details are indicative only and do not provide design solutions that offer complete compliance with local Building Regulations.

Designers should make an allowance for compressive deformation of horizontal members within the height of a wall. Compressive deformation can lead to differential movement between a SIPs wall and, for instance, masonry cladding. An allowance of 10 mm per floor is recommended for horizontal beams of solid timber, or 7 mm per floor for horizontal beams of engineered timber. If there are no horizontal members between the SIPs at each floor, an allowance of 4 mm per floor should be made for the plates and rails.

Table 24: Register of Hemsec Indicative Construction Details and Associated Drawings

Title	View	Reference	Issue
SIP panel vertical joint detail options	Plan	HS-27	0517-A
SIP panel spline joint detail	Plan	HS-25	0517-A
50 mm stud joint detail	Plan	HS-03	0517-A
SIP corner junction detail	Plan	HS-04	0517-A
Structural wall T-junction detail	Plan	HS-05	0517-A
SIPs eaves junction alternative	Section	HS-06	0517-A
Internal roof support showing purlin	Section	HS-07	0517-A
Overlaid panel ridge detail	Section	HS-08	0517-A
Ridge alternatives	Section	HS-09	0517-A
Generic sole plate fixing detail	Section	HS-10	0517-A
Non-structural internal partition wall	Section	HS-11	0517-A
Sole plate mounting to existing blockwork	Section	HS-12	0517-A
External brick tie detail	Section	HS-13	0517-A
External wall	Section	HS-14	0517-A
Internal single party wall	Section	HS-15	0517-A
Internal twin party wall	Section	HS-16	0517-A
Typical supporting wall detail	Section	HS-17	0517-A
SIP internal partition T-junction detail	Plan	HS-18	0517-A
Standard joist hanger detail – intermediate floor	Section	HS-19	0517-A
Concrete beam floor detail	Section	HS-20	0517-A
Typical section through roof detail	Section	HS-21	0517-A
Typical window jamb detail	Section	HS-22	0517-A
Window cill detail	Section	HS-23	0517-A
Typical window head section	Section	HS-24	0517-A

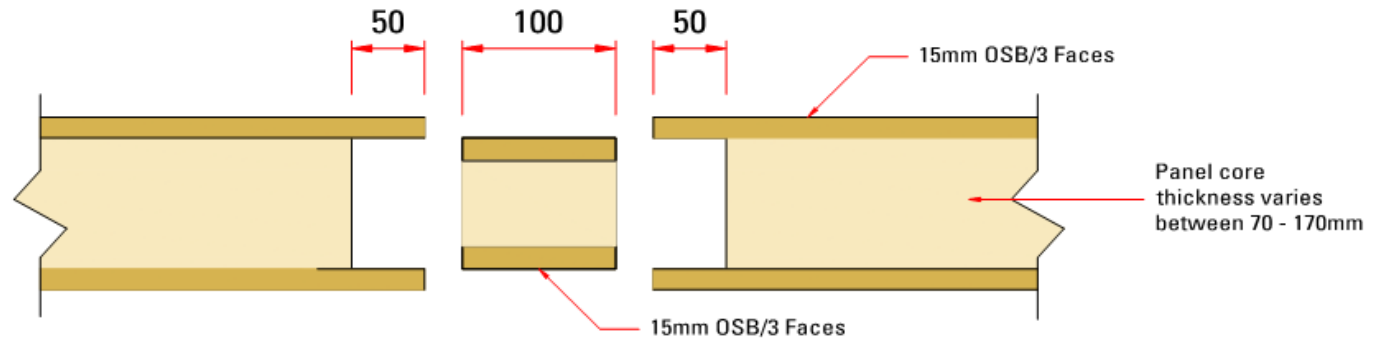

SIP Panel Spline Joint sized to suit panel core thickness
SIP Panel Spline core thickness varies from 70 - 145mm (splines only suitable for 125mm panels and above with 15mm OSB)
ALL DIMENSIONS ARE NOMINALLY SIZED

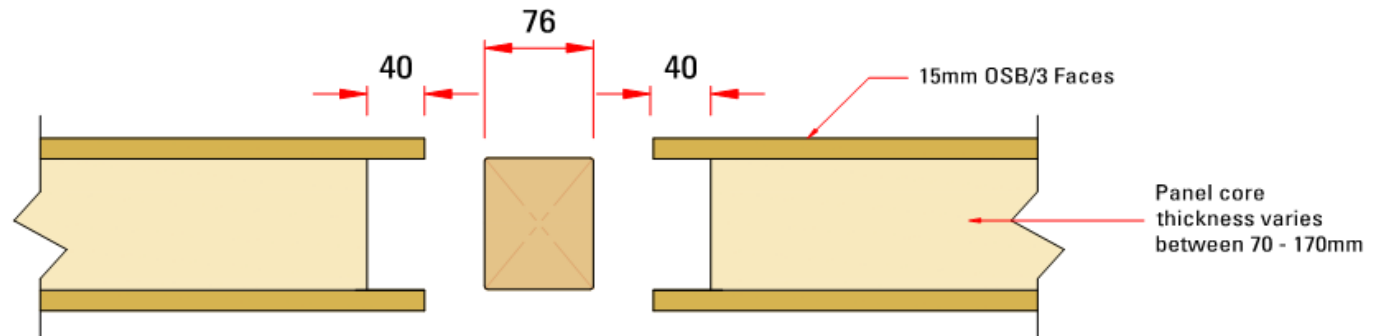

Timber Joint - strength graded to engineers specification and sized to suit panel core thickness
Panel rebates are dependant upon specified timber joint sizes
ALL DIMENSIONS ARE NOMINALLY SIZED

Detail: HS-27
Rev: 0517-A

Drawings should be considered indicative only, as Hemsec SIPS do not underwrite project design.

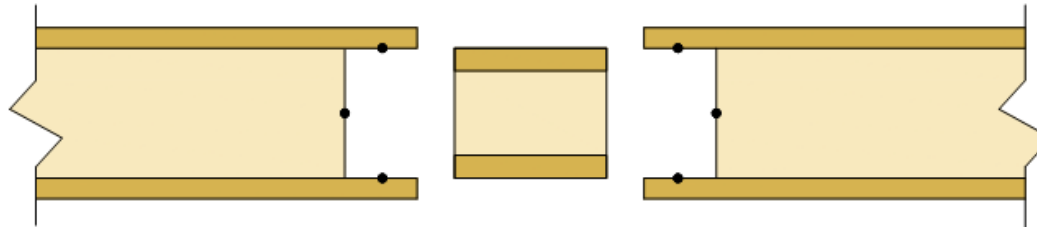

SIP Panel Spline Joint sized to suit panel core thickness
(splines only suitable for 125mm panels and above with 15mm OSB)

Joint fixed with min 40mm GRS nails both sides of joint. CTRs to be determined by structural engineer.
MCPU adhesive applied to inner faces of OSB and rebated core, full height of joint.

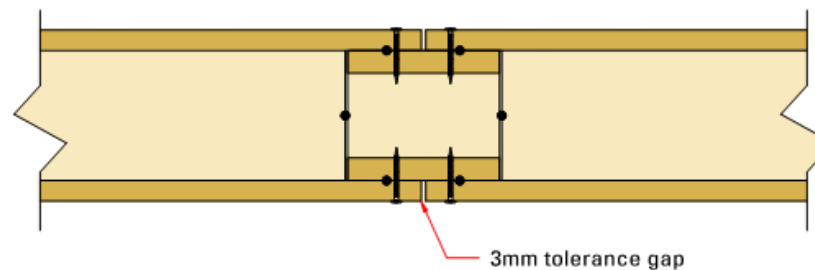

The adhesive should be applied in a small but continuous bead along each face of inner OSB, the full length of the joint.
The joint should be immediately assembled as the adhesive is moisture curing and so will begin to expand and cure once applied.
Once the joint is fixed, the adhesive will cure to form a vapour tight joint.

Detail: HS-25
Rev: 0517-A

Drawings should be considered indicative only, as Hemsec SIPS do not underwrite project design.

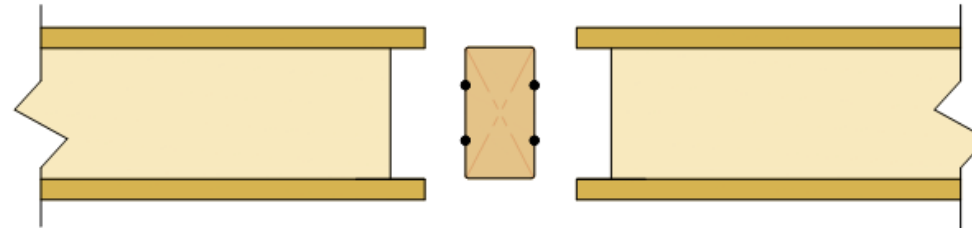

Strength graded timber (determined by structural engineer) sized to suit panel thickness
Panel rebates determined by size of specified joint timber.

Joint fixed with min 40mm GRS nails both sides of joint. CTRs to be determined by structural engineer.
MCPU adhesive applied to faces of stud, full height of joint.

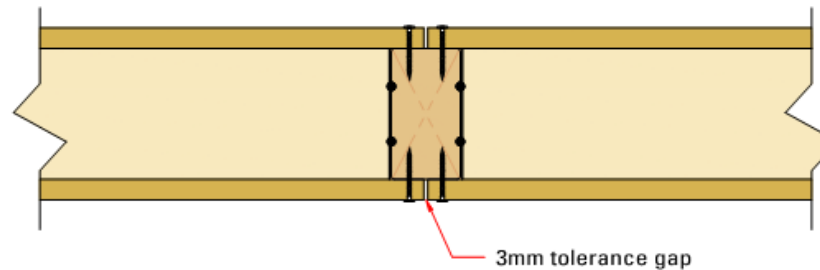

The adhesive should be applied in a small but continuous bead along each face of the timber, the full length of the joint.
The joint should be immediately assembled as the adhesive is moisture curing and so will begin to expand and cure once applied.
Once the joint is fixed, the adhesive will cure to form a vapour tight joint.

Detail: HS-03
Rev: 0517-A

Drawings should be considered indicative only, as Hemsec SIPs do not underwrite project design.

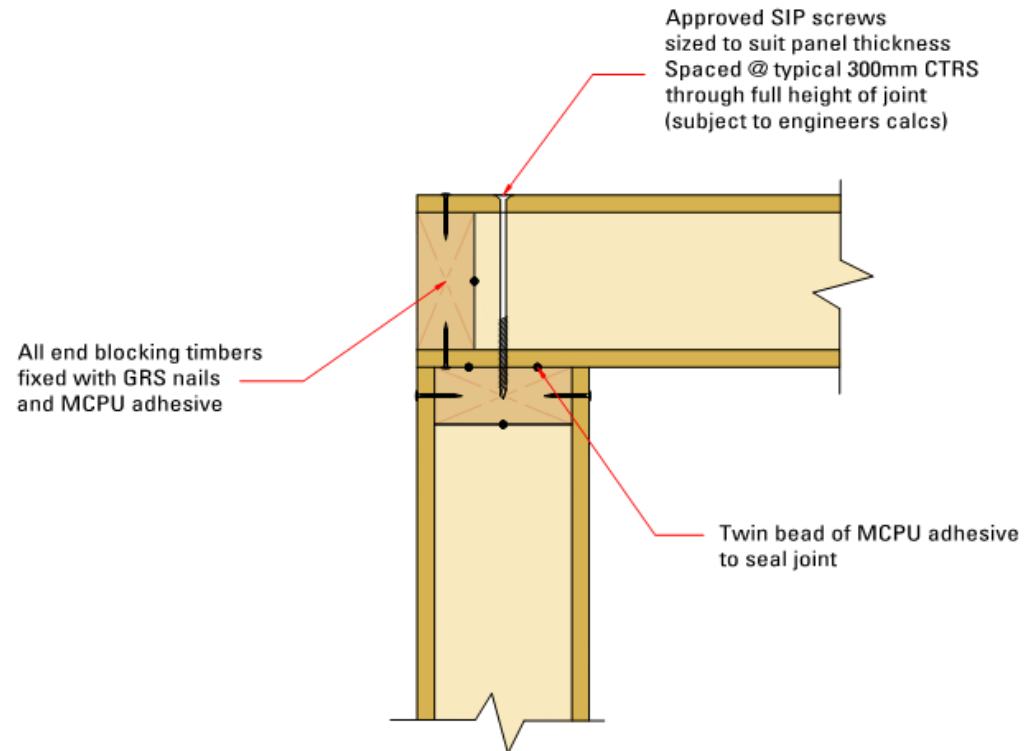

Detail: HS-04
Rev: 0517-A

Drawings should be considered indicative only, as Hemsec SIPS do not underwrite project design.

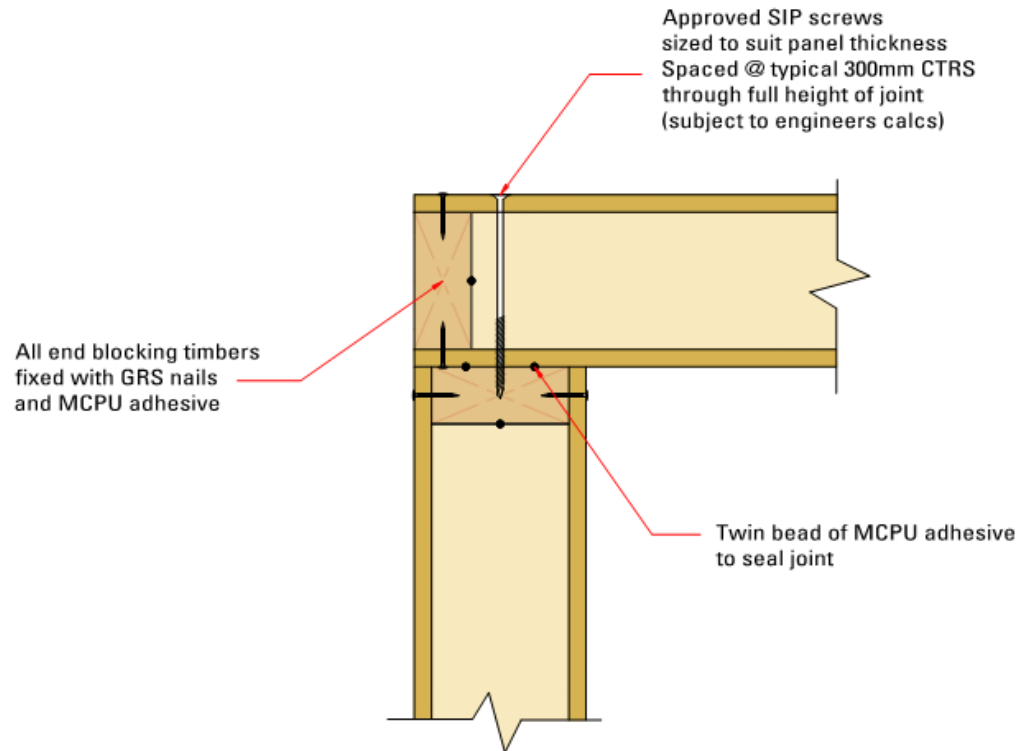

Detail: HS-04
Rev: 0517-A

Drawings should be considered indicative only, as Hemsec SIPS do not underwrite project design.

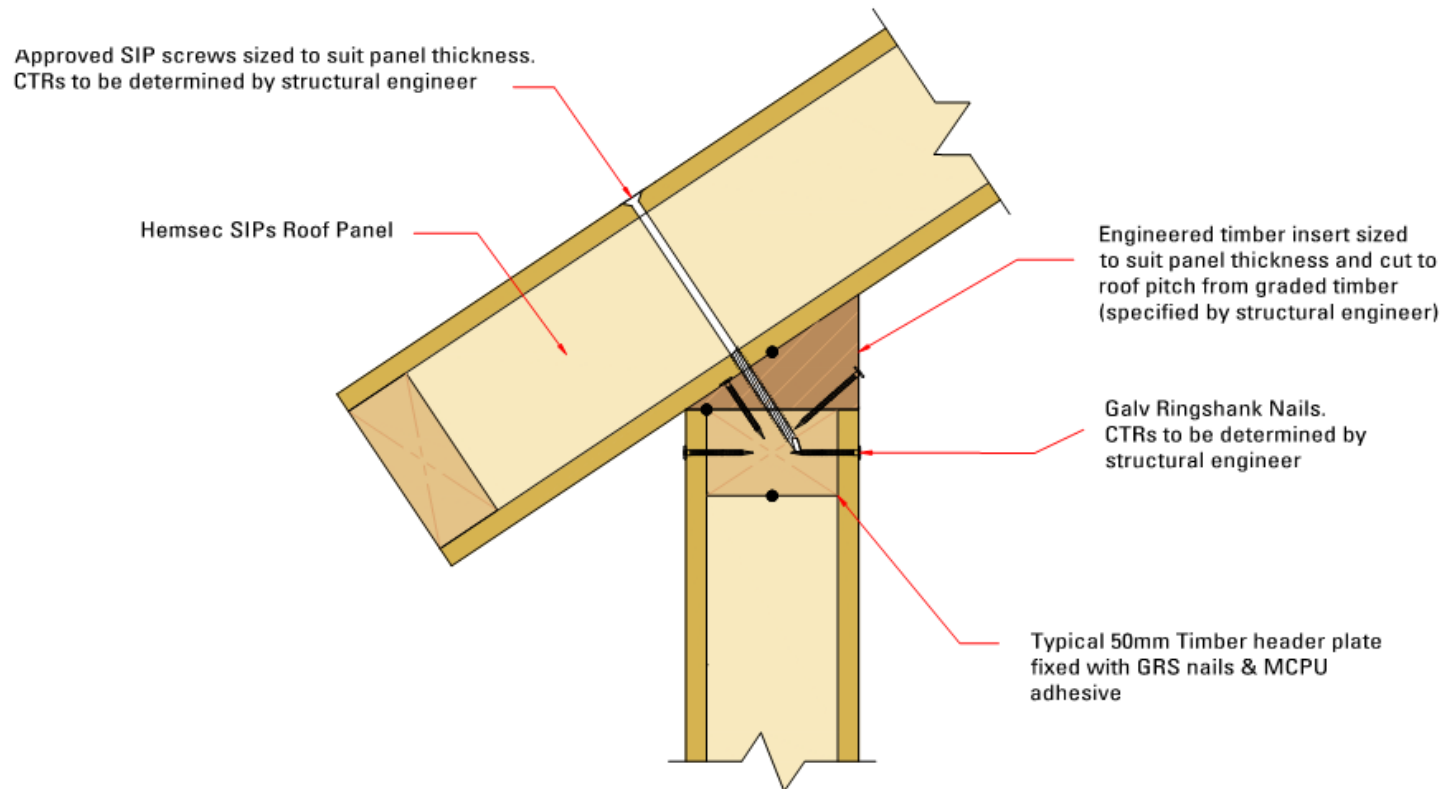

Detail: HS-06
Rev: 0517-A

Drawings should be considered indicative only, as Hemsec SIPS do not underwrite project design.

Approved SIP screws sized to suit panel
thickness @ typical 300mm CTS
(subject to engineer calcs)

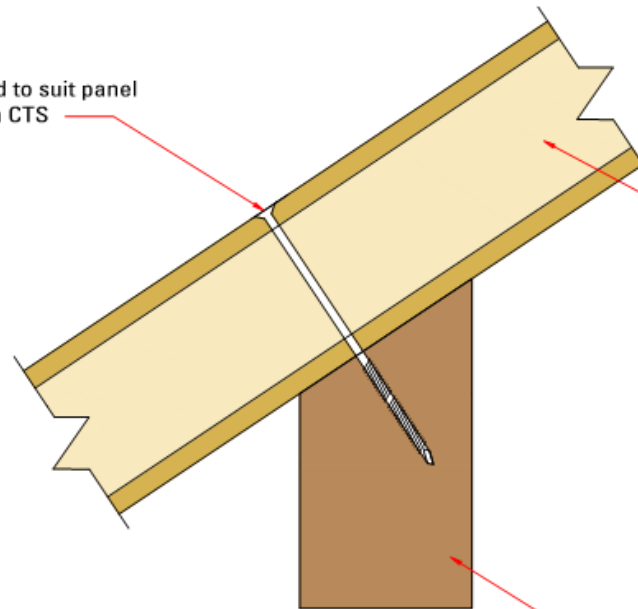

Hemsec SIPs Roof Panel

Purlin sized to suit
(subject to engineer calcs)

Detail: HS-07
Rev: 0517-A

Drawings should be considered indicative only, as Hemsec SIPS do not underwrite project design.

Approved SIP screws sized to suit panel thickness @ typical 300mm CTS (subject to engineer calcs)

GRS Nails sized to suit timber @ 100mm Ctrs

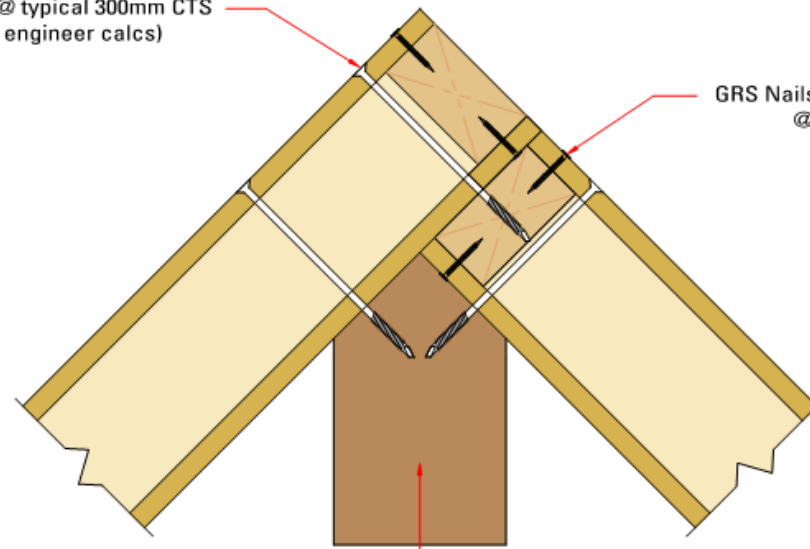

Ridge beam sized to suit (subject to engineers calcs)

Detail: HS-08
Rev: 0517-A

Drawings should be considered indicative only, as Hemsec SIPS do not underwrite project design.

Ridge Alternatives
Section View

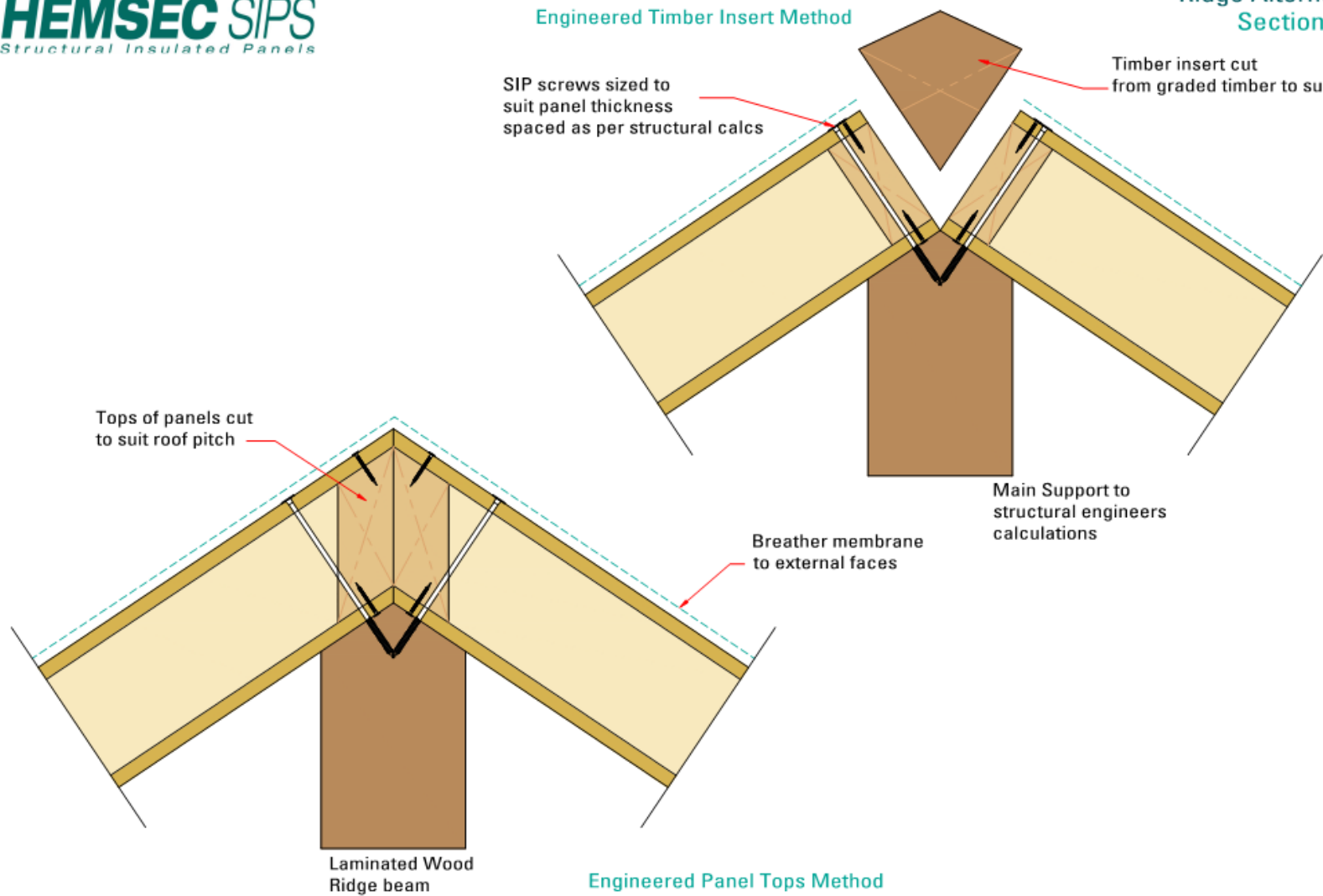

Detail: HS-09
Rev: 0517-A

Drawings should be considered indicative only, as Hemsec SIPS do not underwrite project design.

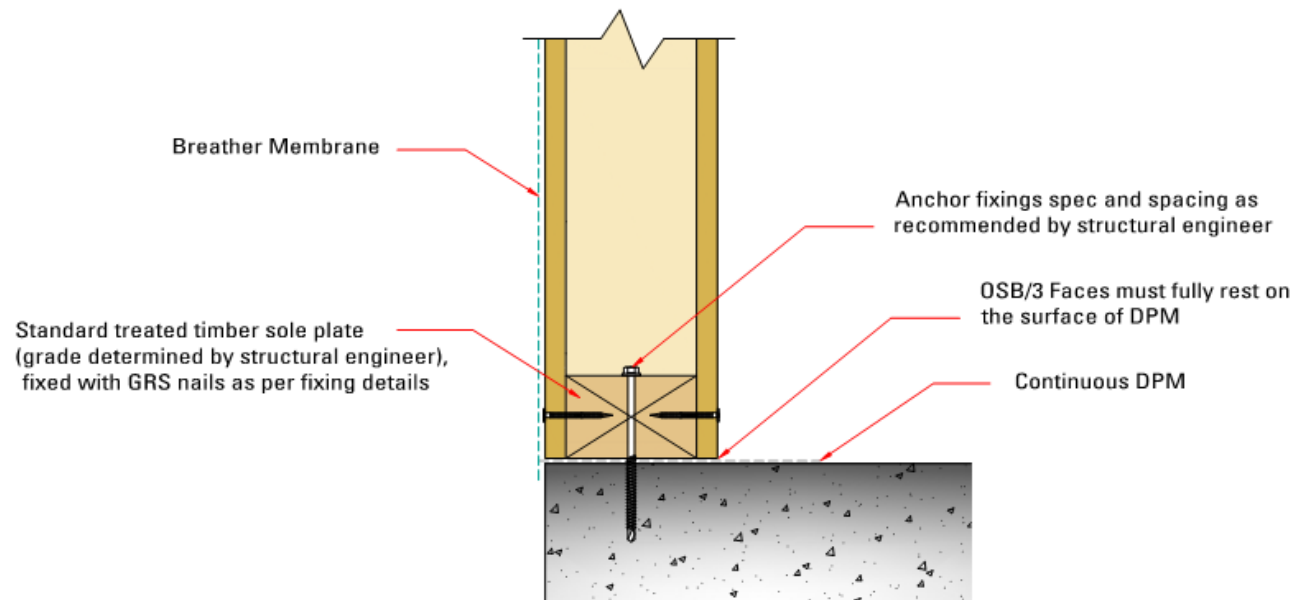

Detail: HS-10
Rev: 0517-A

Drawings should be considered indicative only, as Hemsec SIPs do not underwrite project design.

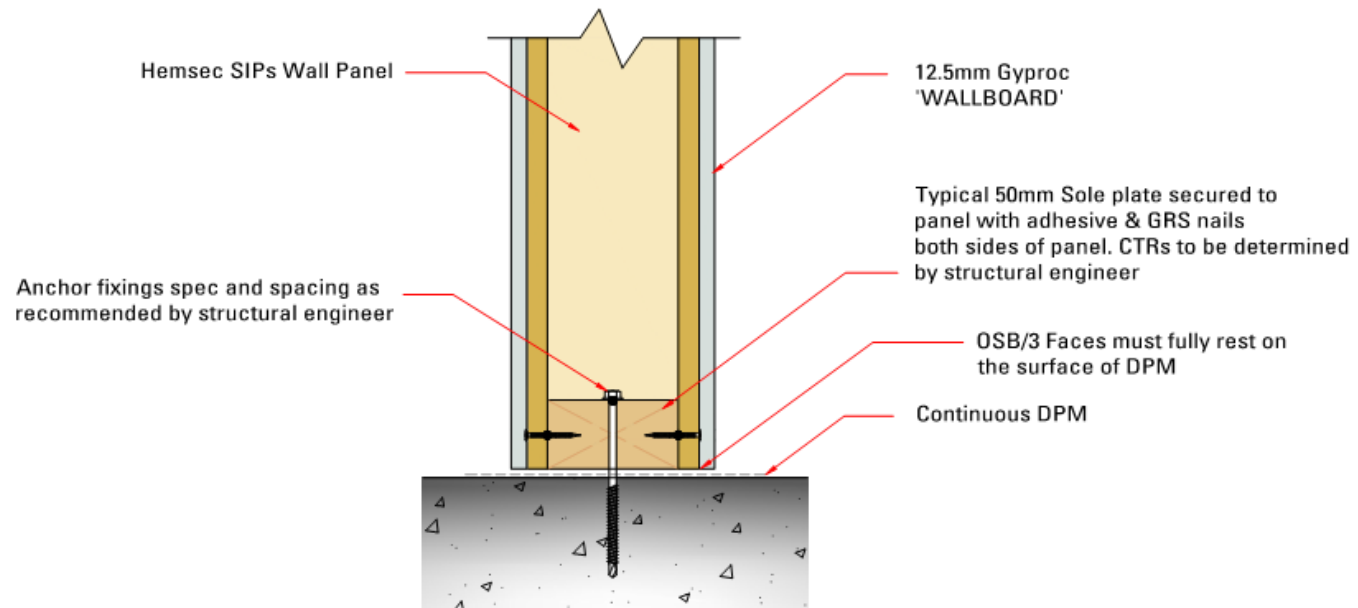

Detail: HS-11
Rev: 0517-A

Drawings should be considered indicative only, as Hemsec SIPS do not underwrite project design.

**Sole Plate Mounting To Existing Blockwork
Section View**

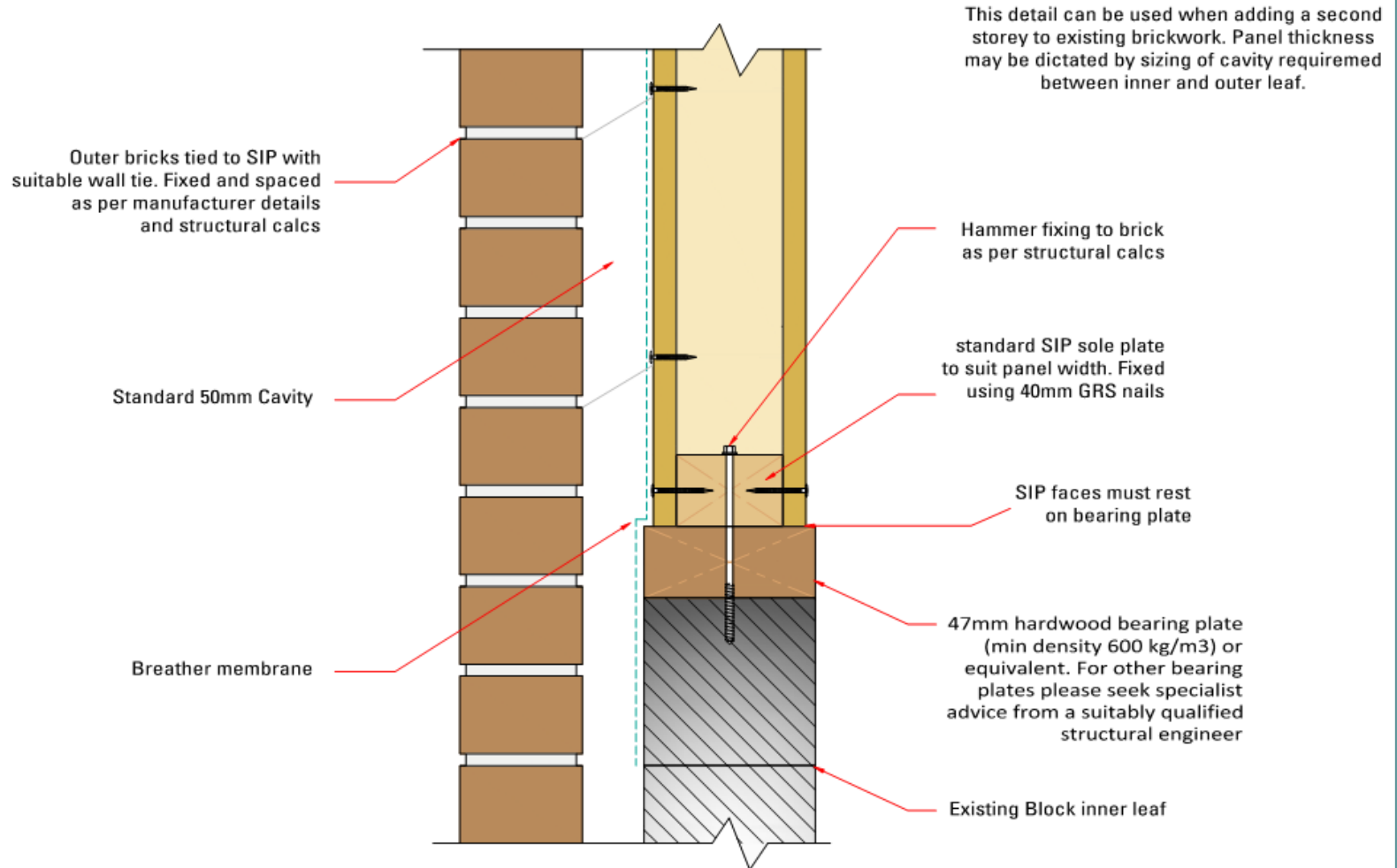

Detail: HS-12
Rev: 0517-A

Drawings should be considered indicative only, as Hemsec SIPS do not underwrite project design.

Density of ties (wind speed less than or equal to 52 m/sec) - 4.4 ties per m² (spacing - 600 x 375 mm)

Density of ties (wind speed greater than 52 m/sec) - 7.0 ties per m² (spacing - 600 x 225mm)

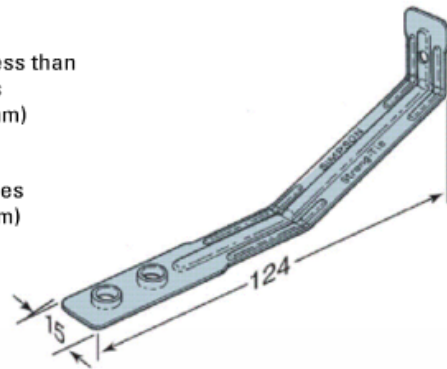

Simpson Strong-tie
BTS50N brick to SIP ties
fixed with SWT50
stainless steel screws

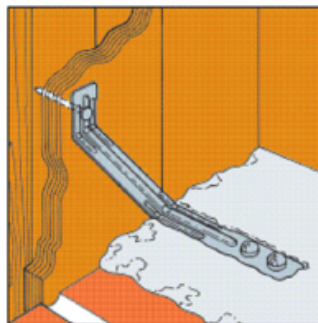

50mm Cavity

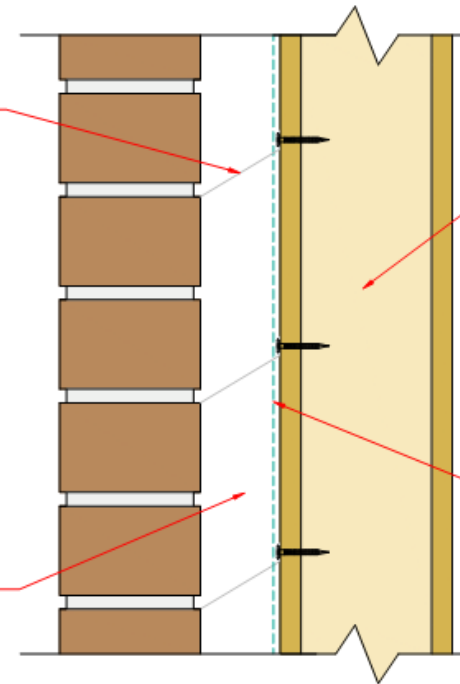

Hemsec SIPs Wall Panel

Breather Membrane

Note:

Other wall-ties can be used as detailed by a qualified structural engineer, who will also advise on differential movement between the SIPs panel and Masonry.

Detail: HS-13
Rev: 0517-A

Drawings should be considered indicative only, as Hemsec SIPS do not underwrite project design.

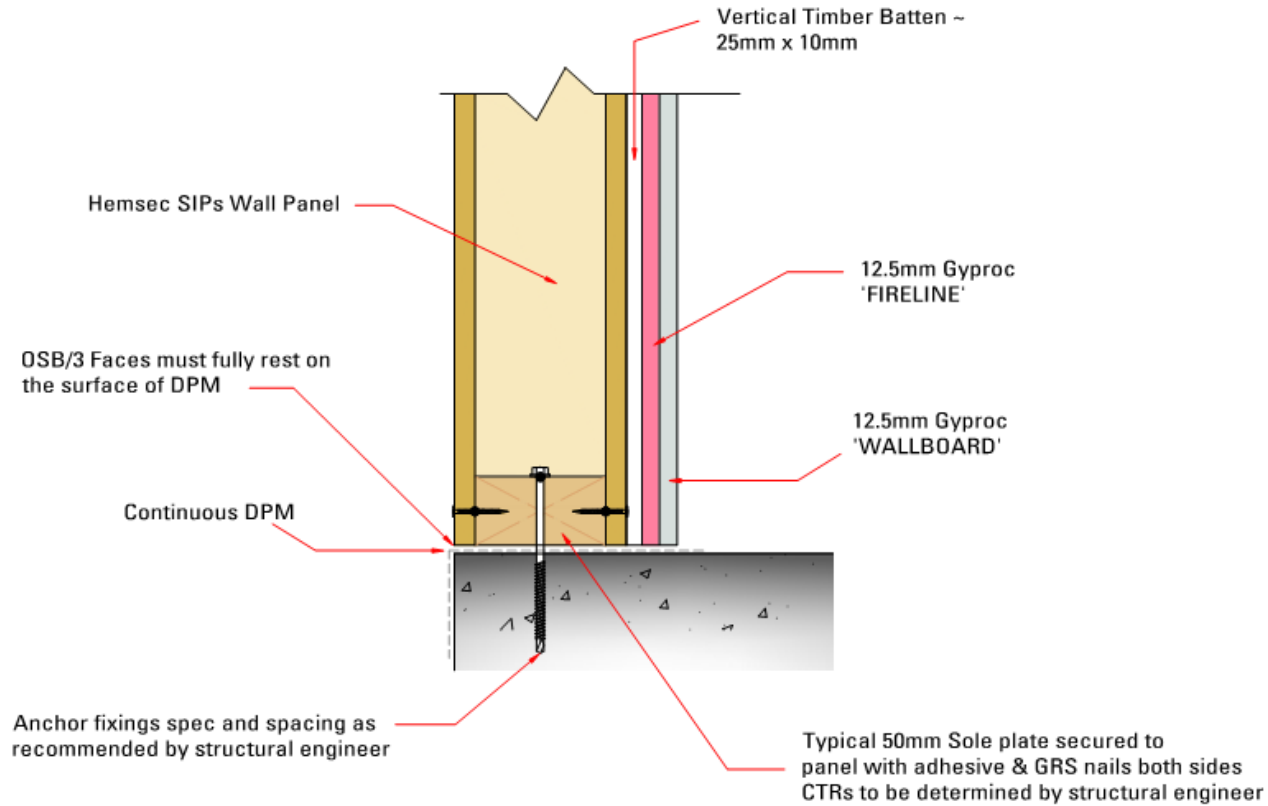

Detail: HS-14
Rev: 0517-A

Drawings should be considered indicative only, as Hemsec SIPS do not underwrite project design.

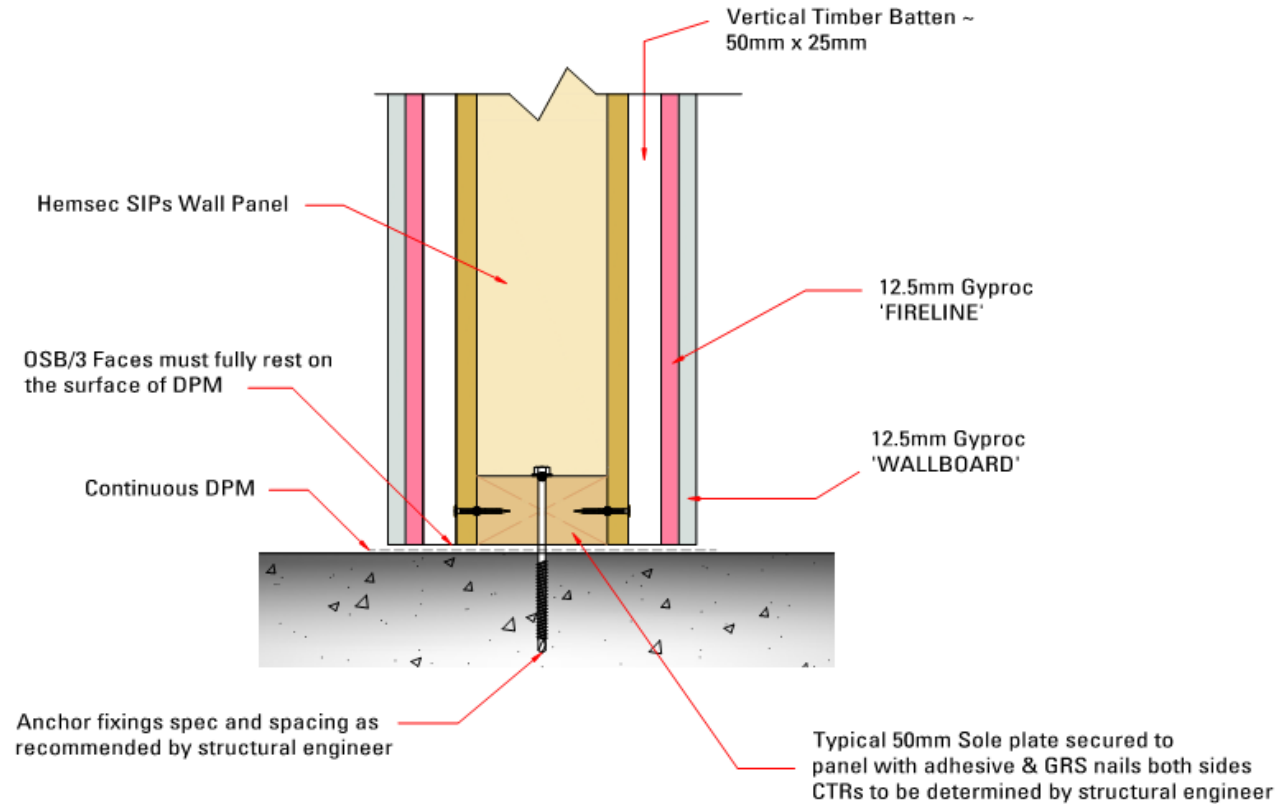

Detail: HS-15
Rev: 0517-A

Drawings should be considered indicative only, as Hemsec SIPS do not underwrite project design.

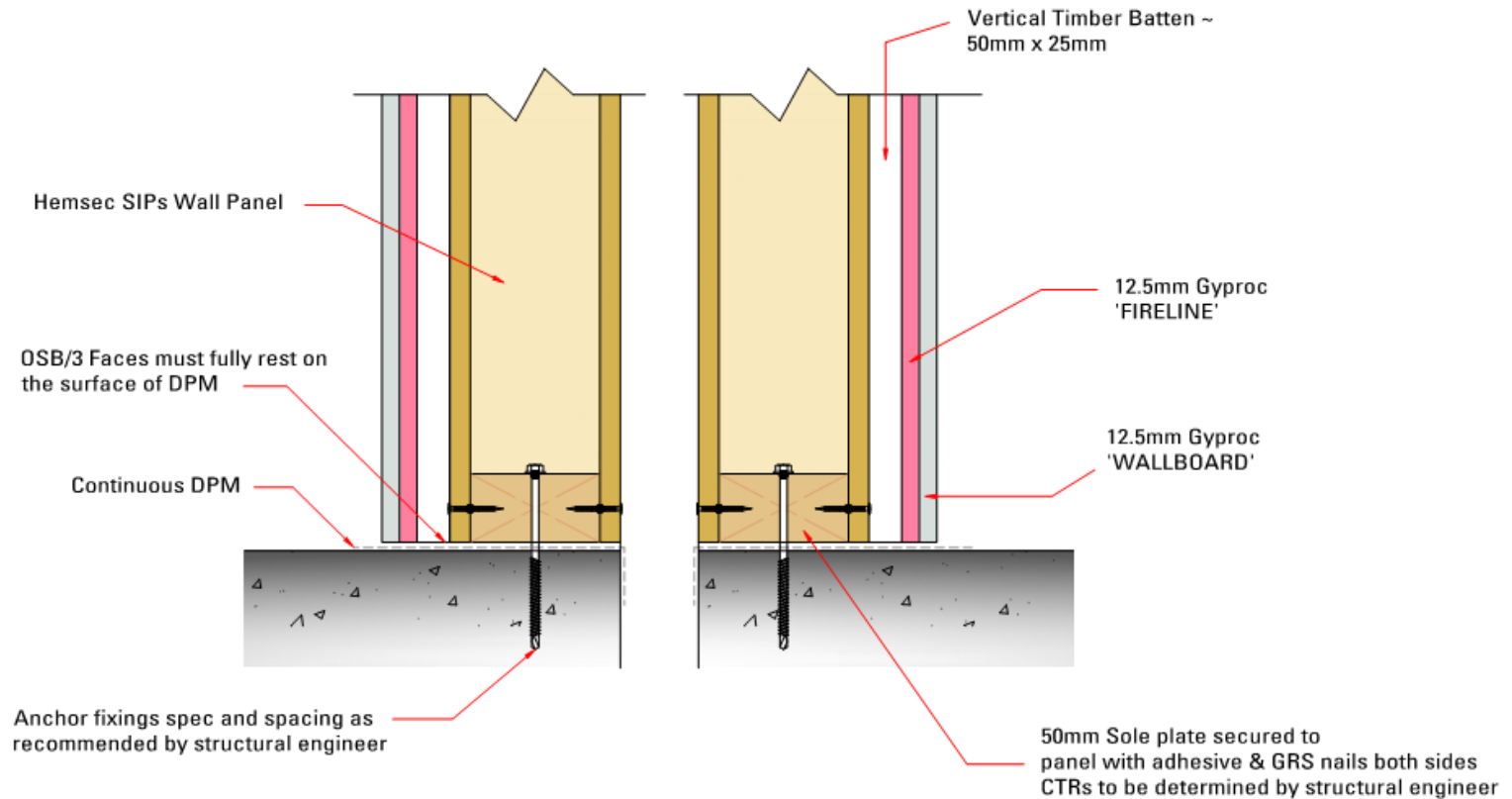

Detail: HS-16
Rev: 0517-A

Drawings should be considered indicative only, as Hemsec SIPS do not underwrite project design.

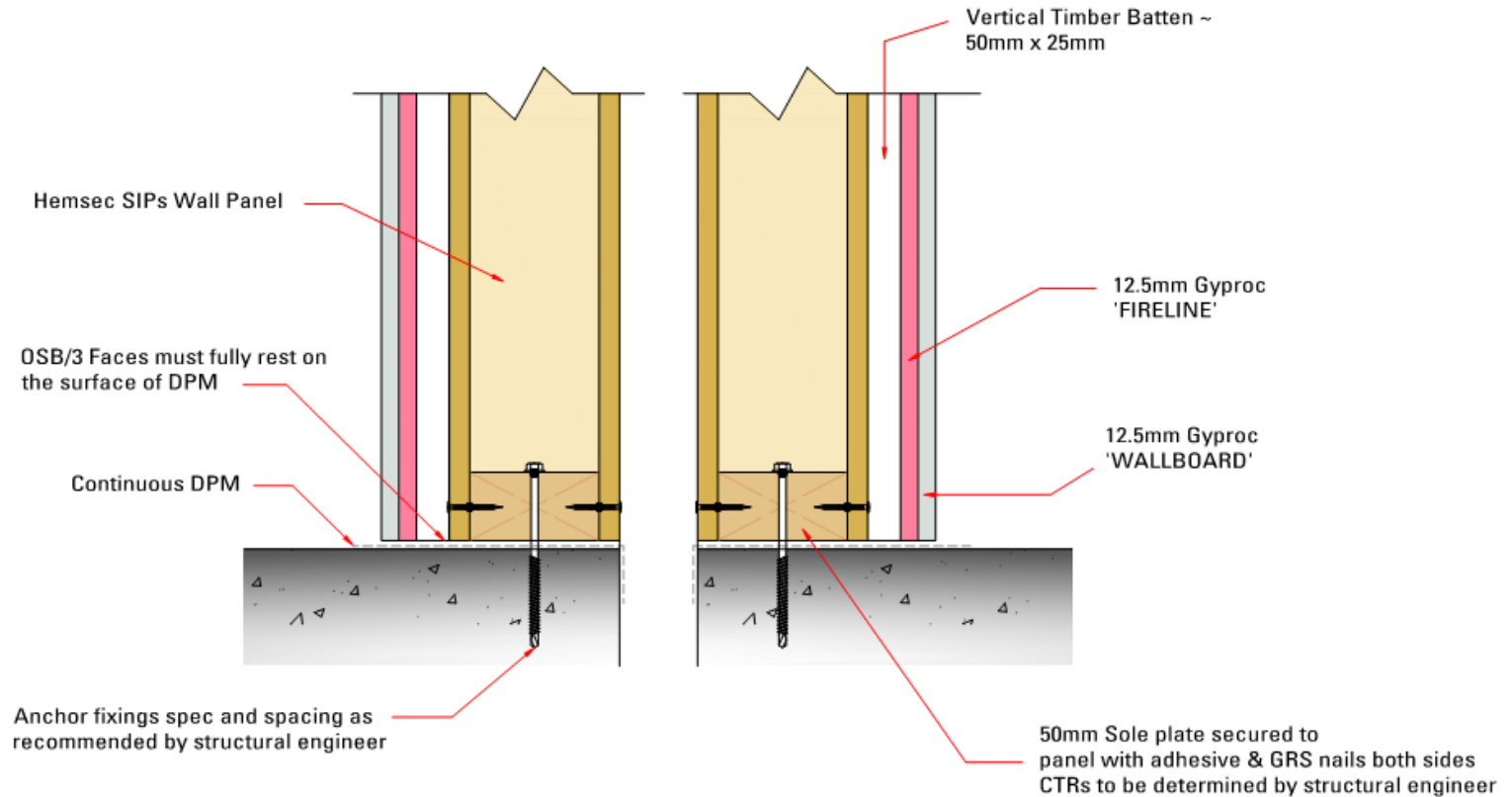

Detail: HS-16
Rev: 0517-A

Drawings should be considered indicative only, as Hemsec SIPS do not underwrite project design.

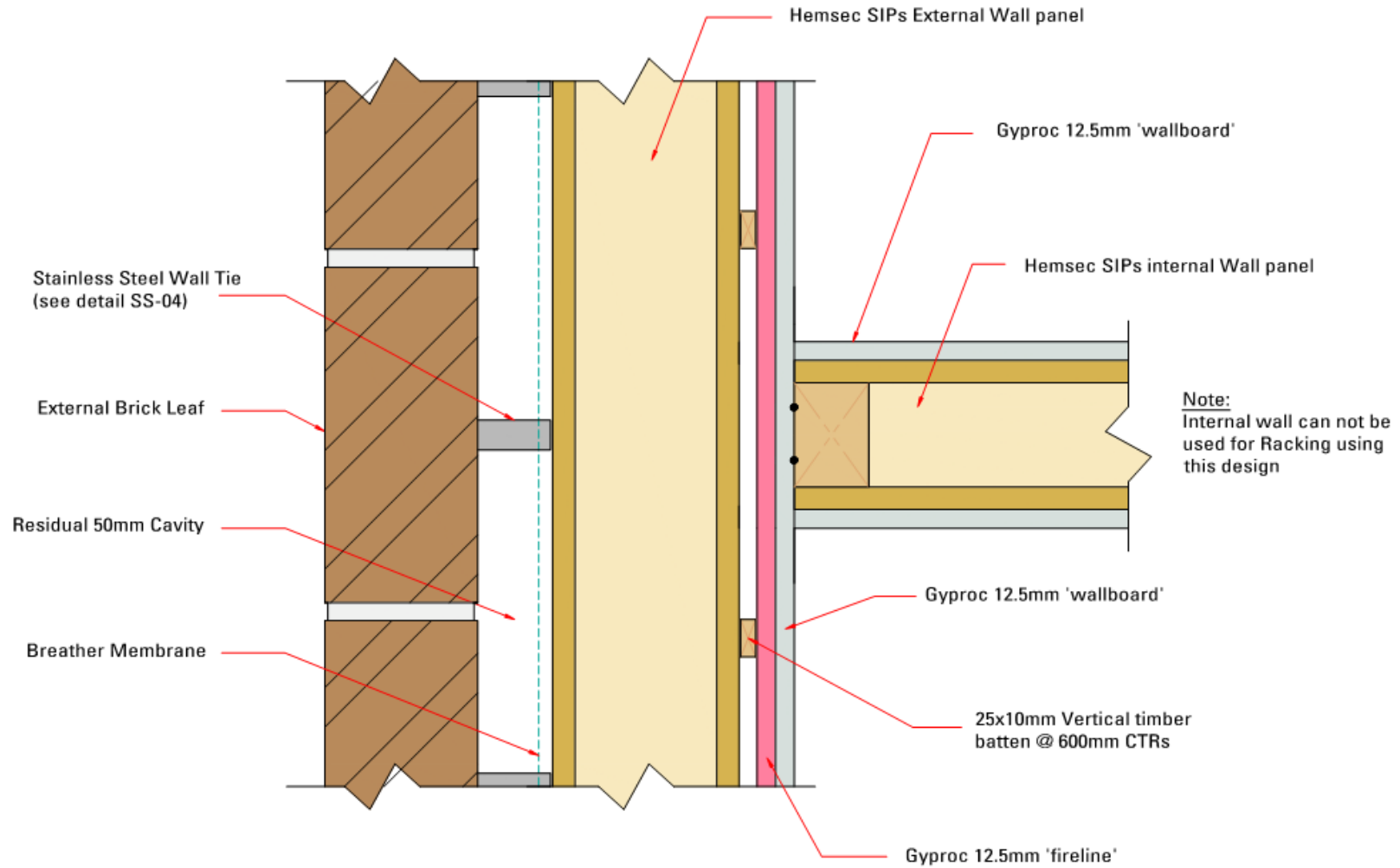

Detail: HS-18
Rev: 0517-A

Drawings should be considered indicative only, as Hemsec SIPS do not underwrite project design.

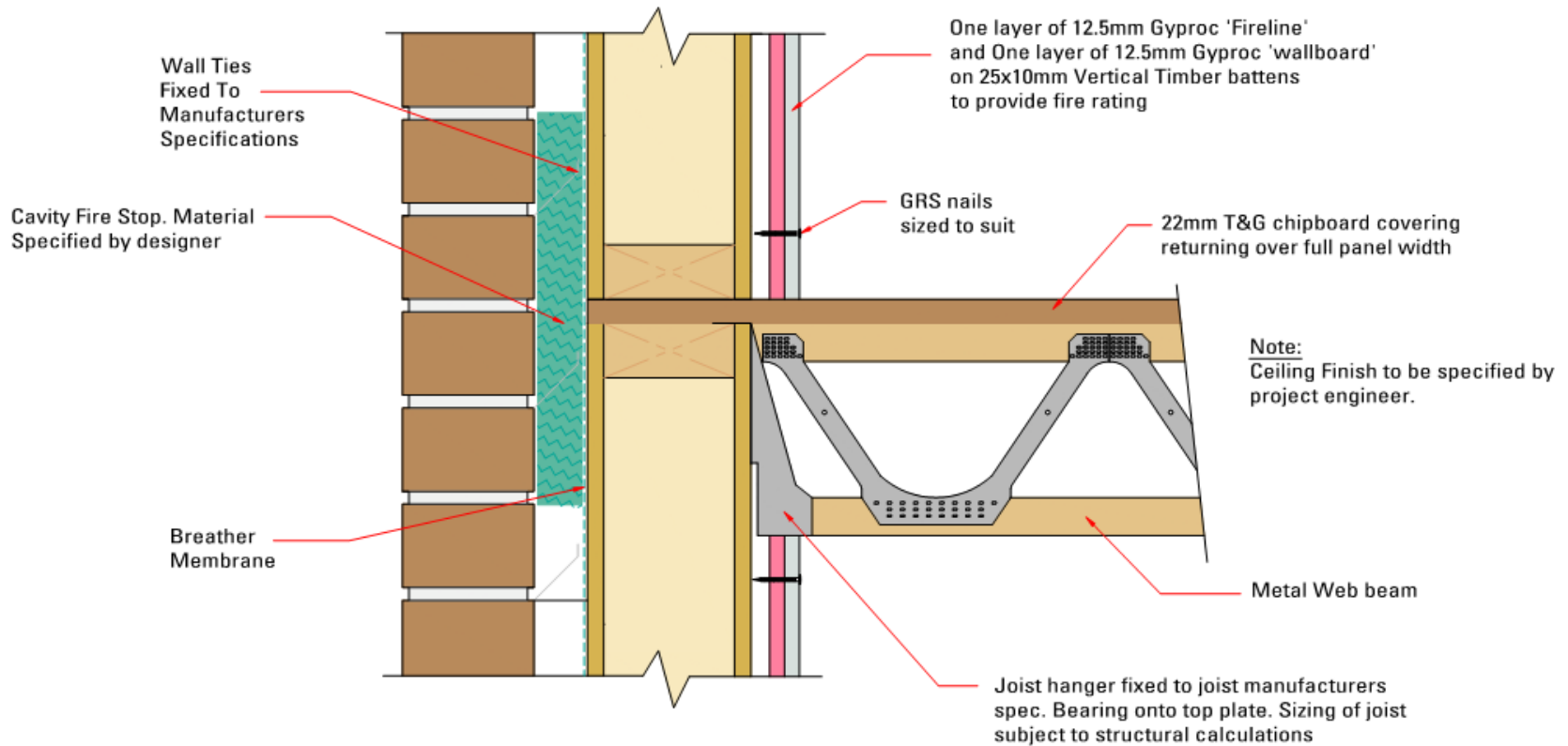

If using this detail with a racking panel please seek specialist advice from a suitably qualified structural engineer.

Detail: HS-19
Rev: 0517-A

Drawings should be considered indicative only, as Hemsec SIPS do not underwrite project design.

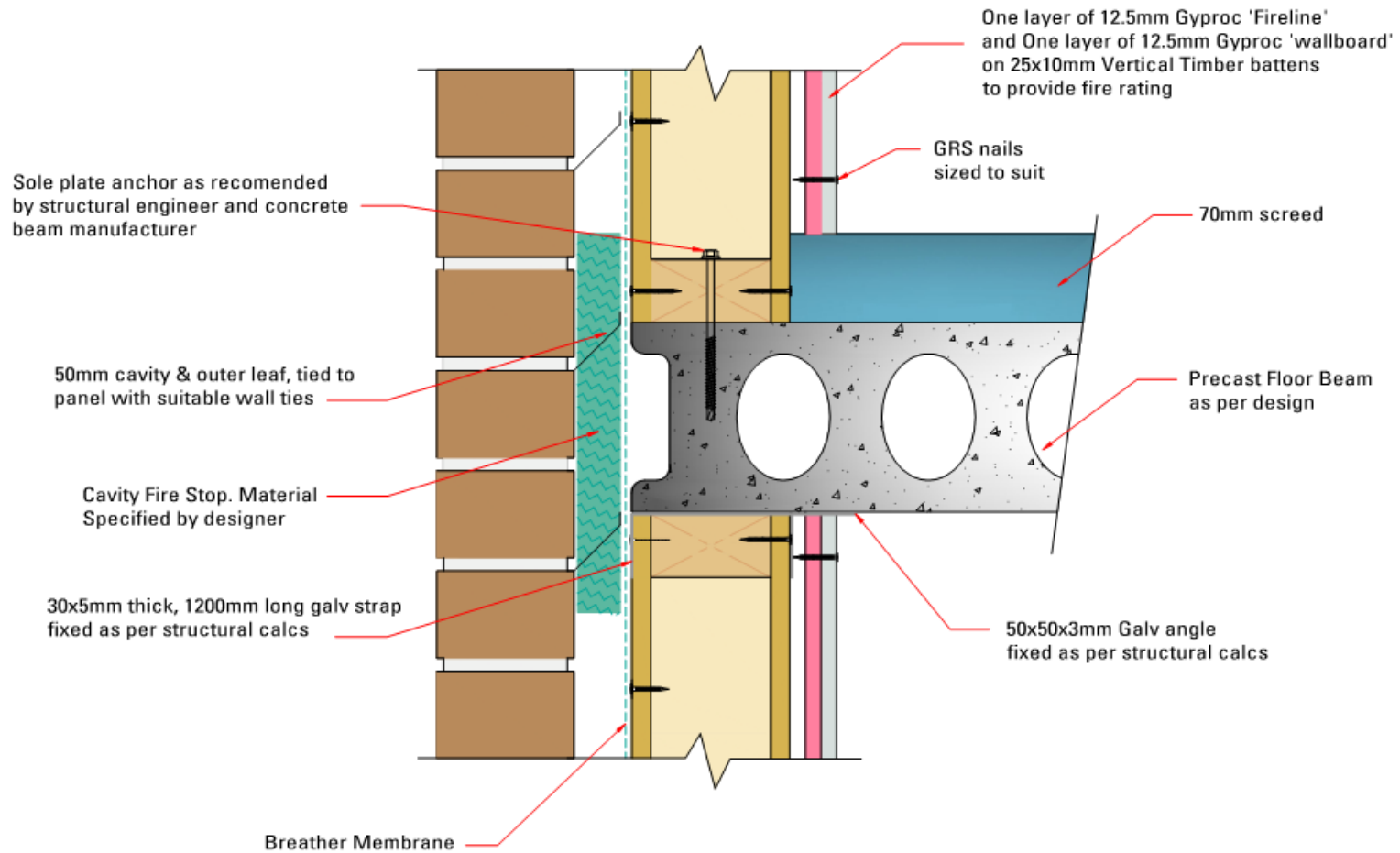

Detail: HS-20
Rev: 0517-A

Drawings should be considered indicative only, as Hemsec SIPs do not underwrite project design.

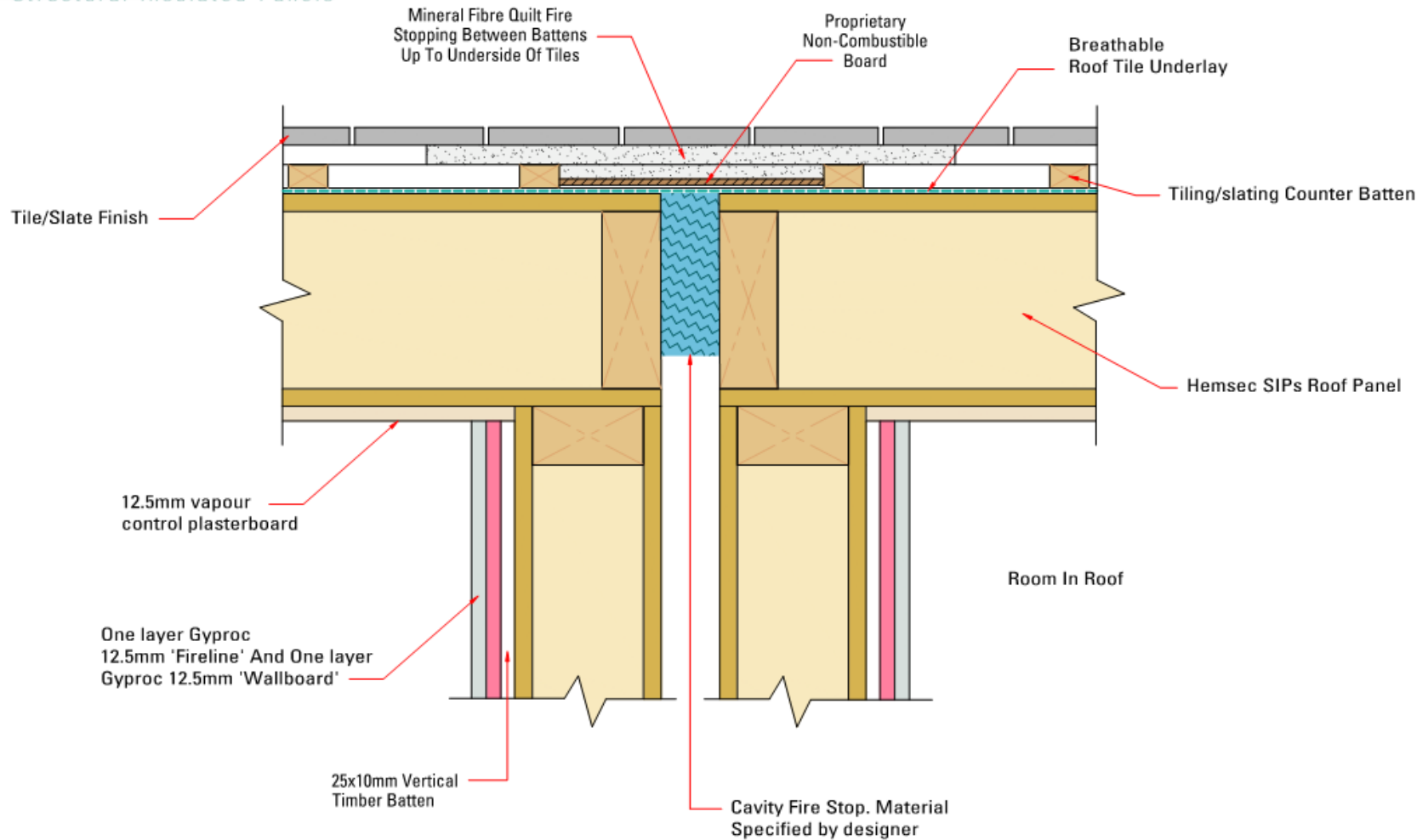

Detail: HS-21
Rev: 0517-A

Drawings should be considered indicative only, as Hemsec SIPS do not underwrite project design.

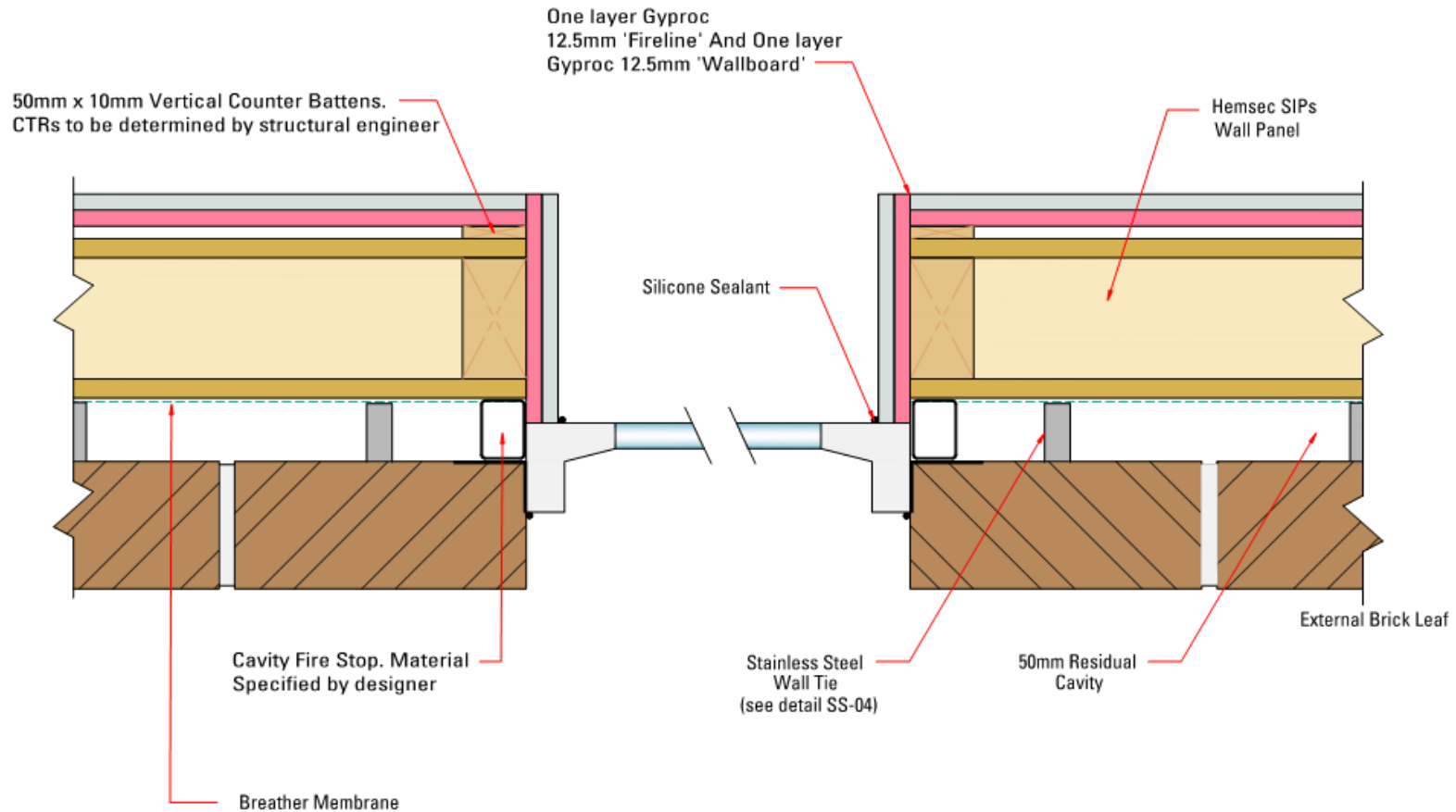

Detail: HS-22
Rev: 0517-A

Drawings should be considered indicative only, as Hemsec SIPS do not underwrite project design.

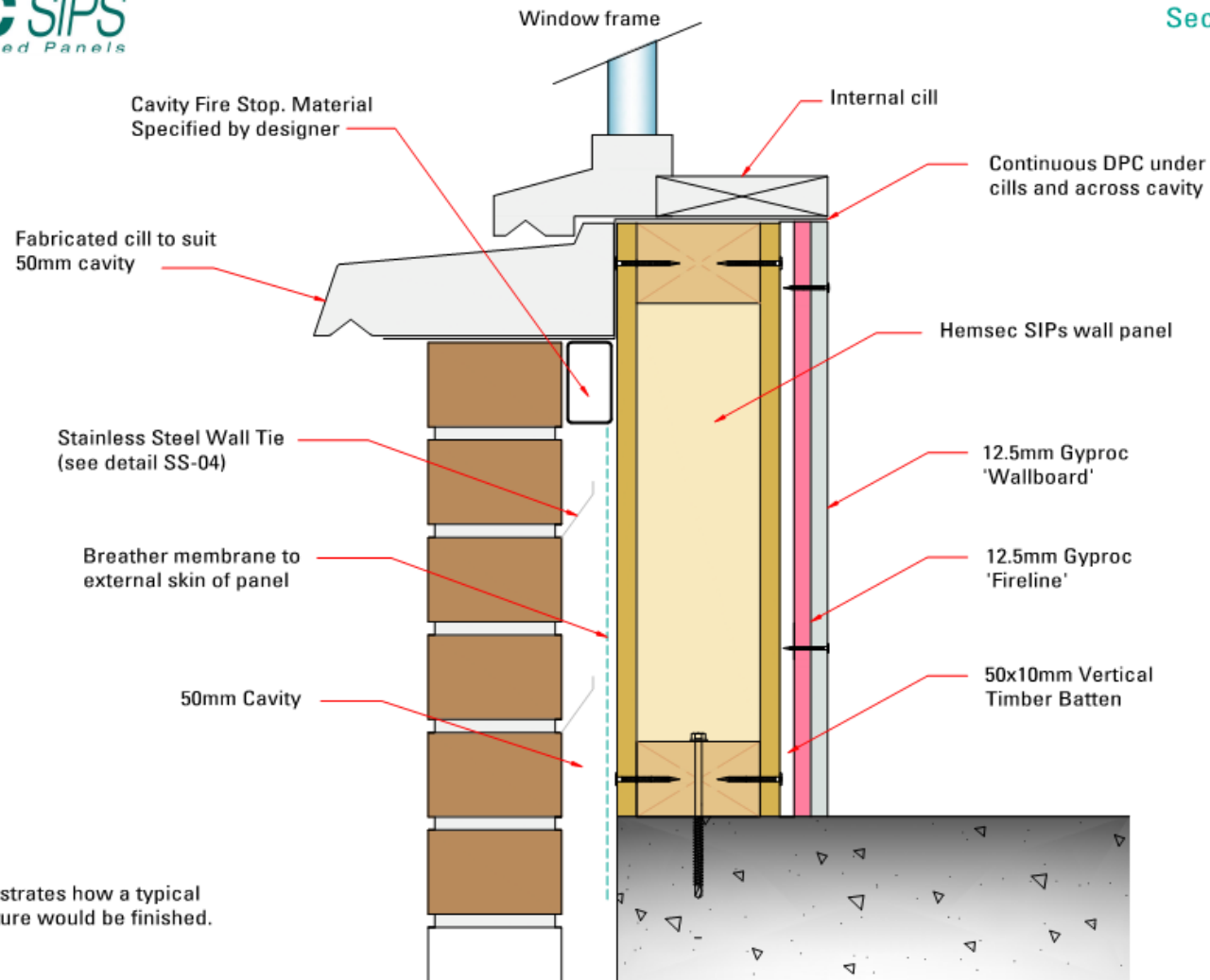

This detail illustrates how a typical window aperture would be finished.

Detail: HS-23
Rev: 0517-A

Drawings should be considered indicative only, as Hemsec SIPs do not underwrite project design.

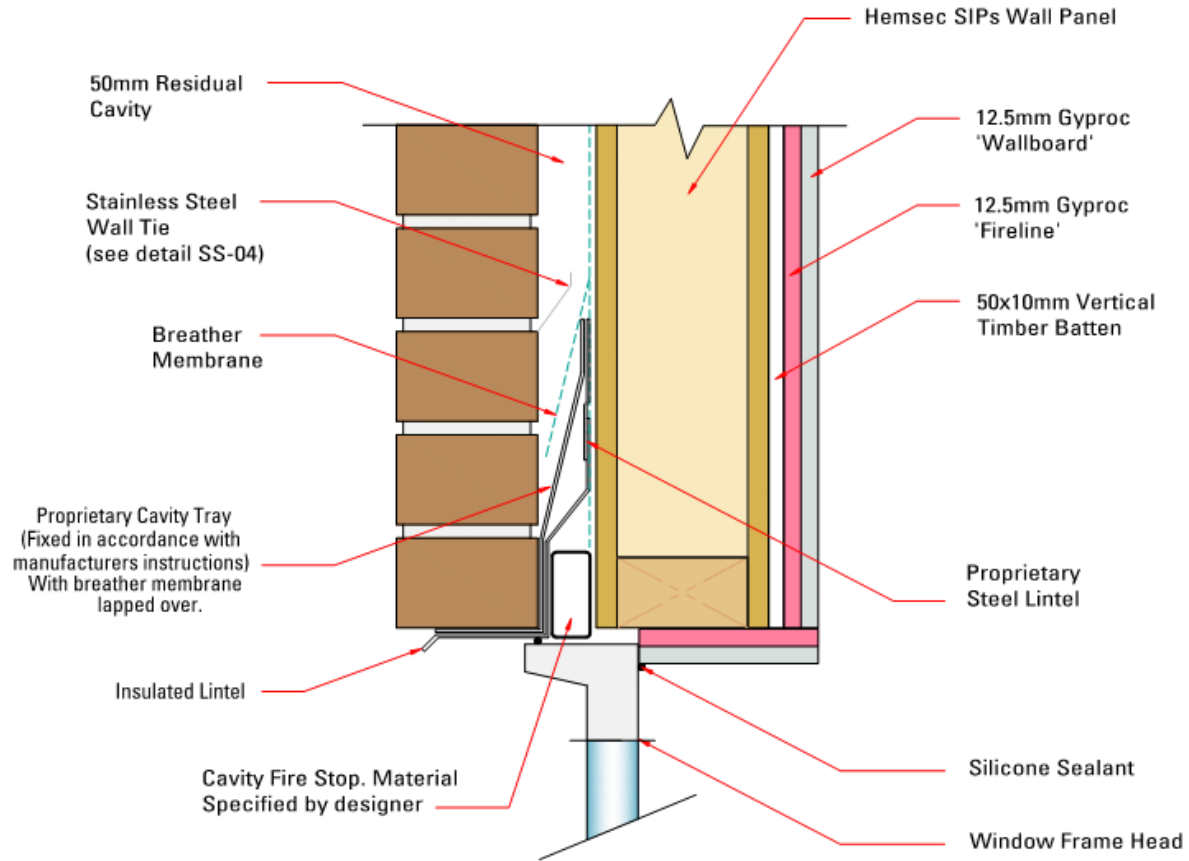

Detail: HS-24
Rev: 0517-A

Drawings should be considered indicative only, as Hemsec SIPS do not underwrite project design.